

SA's Leading Past Year

Exam Paper Portal

STUDY

You have Downloaded, yet Another Great Resource to assist you with your Studies 😊

Thank You for Supporting SA Exam Papers

Your Leading Past Year Exam Paper Resource Portal

Visit us @ [www.saexampapers.co.za](http://www.saexampapers.co.za)



SA EXAM  
PAPERS

<b>TABLE OF CONTENTS</b>		<b>PAGE</b>
<b>1.</b>	Introduction	<b>3</b>
<b>2.</b>	How to use this Self-study Guide	<b>4</b>
<b>3.</b>	Responding to the environment: Humans	<b>5</b>
	<b>3.1</b> Notes/Summaries/Key concepts/ Study and Examination Tips	<b>13</b>
	<b>3.2</b> Questions	<b>28</b>
	<b>3.3</b> Answers	<b>33</b>
<b>4.</b>	Responding to the Environment: Plants	<b>40</b>
	<b>4.1</b> Notes/Summaries/Key concepts/ Study and Examination Tips	<b>46</b>
	<b>4.2</b> Questions	<b>62</b>
	<b>4.3</b> Answers	<b>68</b>
<b>5.</b>	References	<b>71</b>
<b>6.</b>	Acknowledgements	<b>71</b>

## 1. INTRODUCTION

The declaration of COVID-19 as a global pandemic by the World Health Organisation led to the disruption of effective teaching and learning in many schools in South Africa. The majority of learners in various grades spent less time in class due to the phased-in approach and rotational/alternate attendance system that was implemented by various provinces. Consequently, most schools were not able to complete all the relevant content designed for specific grades in accordance with the Curriculum and Assessment Policy Statements in most subjects.

As part of mitigating against the impact of COVID-19 on the current Grade 12, the Department of Basic Education (DBE) worked in collaboration with subject specialists from various Provincial Education Departments (PEDs) and developed this Self-Study Guide. The Study Guide covers those topics, skills and concepts that are located in Grade 12, that are critical to lay the foundation for Grade 12. The main aim is to close the pre-existing content gaps to strengthen the mastery of subject knowledge in Grade 12. More importantly, the Study Guide will engender the attitudes in the learners to learning independently while mastering the core cross-cutting concepts.

## 2. HOW TO USE THIS REVISION BOOKLET

- You must use this Revision booklet together with the *Life Sciences Mind the Gap Study Guide*, which is a complementary booklet.
- You need to study the content from the *DBE Grade 12 Textbook*, *DBE Exam Guideline 2021*, and *Mind the Gap* for all the topics.
- Ensure you understand all the relevant concepts and content.
- THIS Self-study Guide focusses mainly on the skills you will need to answer the questions in examinations.
- Section 2 focusses on general tips to approach certain question types in the Life Sciences question papers:
  - How to answer multiple choice questions
  - How to master the relevant terminology
  - Answering matching questions
  - Drawing and interpreting of graphs
  - Interpreting tables
  - Interpreting diagrams
  - Doing calculations
- Section 3 deals with the following:
  - Examples of remembering questions in each paper per topic are given.
  - Tips are provided on how to approach the answering of these questions.
  - References are made on how to link the questions to Mind the Gap
  - Practice questions per topic are provided
- Section 4 deals with the following:
  - Examples of understanding questions in each paper per topic are given.
  - Tips are provided on how to approach the answering of these questions.
  - References are made on how to link the questions to Mind the Gap
  - Practice questions per topic are provided
- Section 5 deals with the following:
  - Examples of application, analysing, synthesising, and evaluation questions in each paper per topic are given.
  - Tips are provided on how to approach the answering of these questions.
  - References are made on how to link the questions to Mind the Gap
  - Practice questions per topic are provided

### 3. RESPONDING TO THE ENVIRONMENT: HUMANS (54 MARKS)

<b>TOPIC: RESPONDING TO THE ENVIRONMENT (HUMANS)</b>			
<b>Term</b>	2	Paper	1
<b>Duration</b>	4 weeks	Weighting	<b>54 marks</b> <b>36%</b>
<b>PRIOR KNOWLEDGE/ BACKGROUND KNOWLEDGE</b>			
<b>Gr 10: Animal tissues: neurons; Natural Sciences Gr 5: sense organs</b>			
<b>RESOURCES:</b>			
Mind the Gap Life Sciences Study Guide Gr 12 pg. 41-52			
DBE Gr 12 Life Sciences Text book pgs. 152-197			
Past LFSC Papers: NSC; SC and Provincial Papers 2017-2020			

*The nervous system is divided into the central nervous system and the peripheral nervous system.*

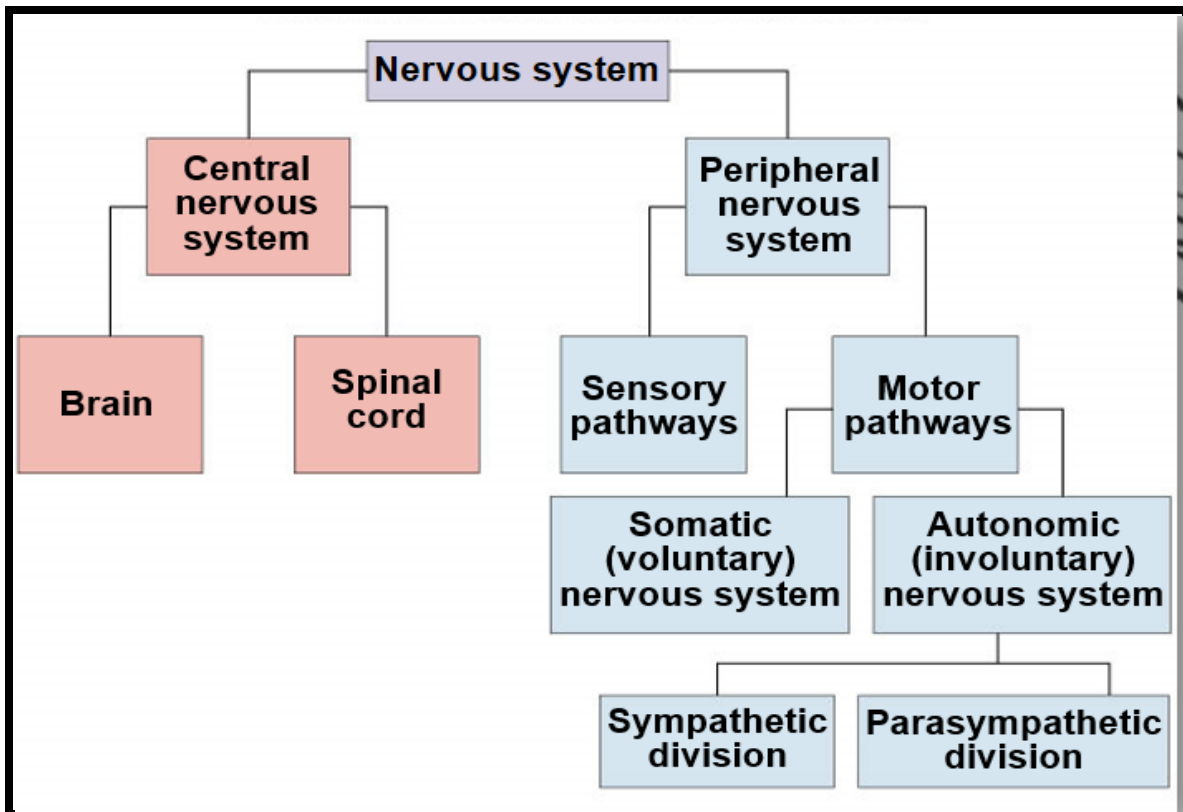

BIOLOGICAL TERM	DESCRIPTION
<b>Alzheimer's Disease</b>	Progressive mental deterioration that can occur in middle or old age, due to generalized degeneration of the brain
<b>Autonomic nervous system</b>	The part of the peripheral nervous system that controls involuntary actions
<b>Axon</b>	The long threadlike part of a nerve cell along which impulses are conducted from the cell body to other cells
<b>Central nervous system (CNS)</b>	The part of the nervous system that consist of the brain and spinal cord
<b>Cerebrospinal fluid</b>	A watery <i>fluid</i> , continuously produced and absorbed, which flows in the ventricles (cavities) within the brain and around the surface of the brain and spinal cord
<b>Corpus callosum</b>	The structure that connects the left and right hemispheres of the brain, allowing communication between them
<b>Dendrite</b>	A part of the neuron that conducts impulses towards the cell body
<b>Effectors</b>	Are muscles or glands that cause a response to the message from the nervous system (brain and spinal cord)
<b>Medulla oblongata</b>	The part of the brain that controls the heart rate
<b>Meninges</b>	A collective name for the membranes that protect the brain
<b>Motor neuron</b>	Neuron that carries impulses from the CNS to the effector
<b>Multiple sclerosis</b>	A disorder of the nervous system that is characterised by the breakdown of the myelin sheath of neurons
<b>Myelin sheath</b>	A fatty layer wrapped around the axon, which acts as insulation
<b>Nerve</b>	Bundle of neurons
<b>Neurons</b>	Specialised nerve cells found in the nervous system
<b>Neurotransmitter</b>	Chemical that is released from a nerve cell which thereby transmits an impulse from a nerve cell to another nerve, muscle, organ, or other tissue
<b>Parasympathetic nerves</b>	Nerves that slow down a particular action in the body after the action has had its desired effect
<b>Peripheral nervous system</b>	The part of the nervous system made up of cranial and spinal nerves

## TERMINOLOGY: THE HUMAN NERVOUS SYSTEM

<b>Receptors</b>	Structures located in the sense organs. They convert a stimulus into an impulse
<b>Sensory neuron</b>	Neuron that carries impulses to the Central Nervous System
<b>Stimulus</b>	A detectable change (e.g. pain, heat, light, sound) that will be received by a receptor and converted into an impulse
<b>Sympathetic nerves</b>	Nerves that increase a particular action in the body
<b>Synapse</b>	A junction between two nerve cells, consisting of a minute gap across which impulses pass by diffusion of neurotransmitters

### Human nervous system – Diagrams

#### Brain

**Labels: Know only:** Cerebellum, Cerebrum, Corpus callosum, Medulla oblongata, Spinal cord, Hypothalamus, Pituitary gland

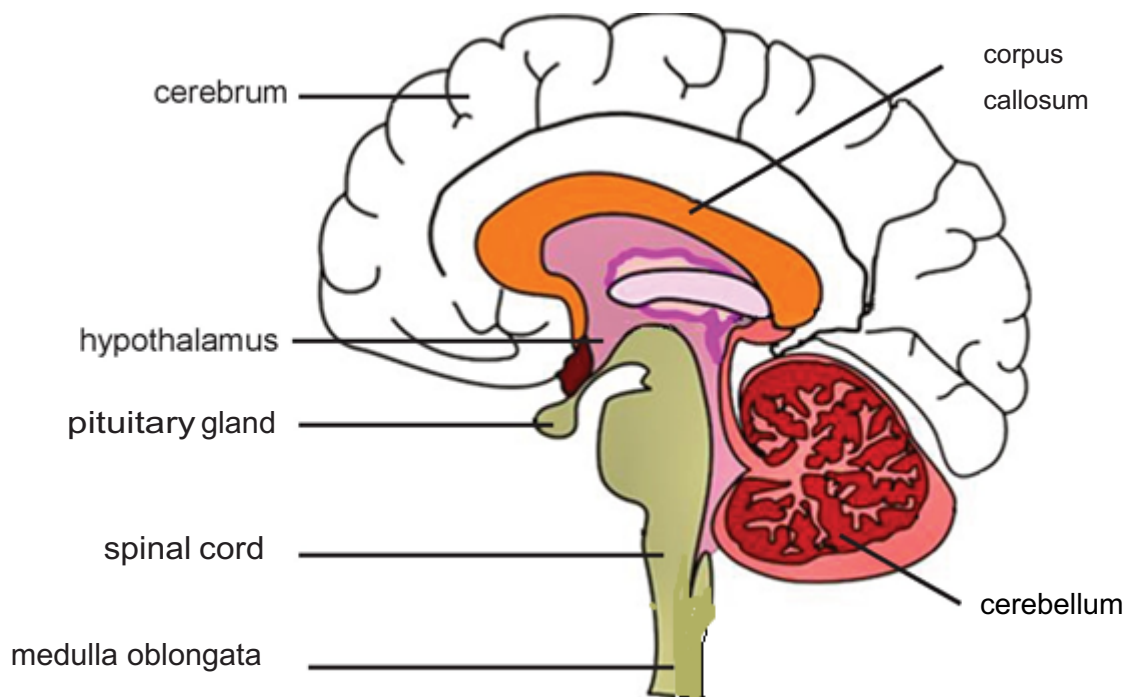

#### Neurons:

They are nerve cells; there are **THREE** types.

**Labels: Know only:** Nucleus, Cell body, Cytoplasm, Myelin sheath, Axon, Dendrites

## 1. MOTOR NEURON/EFFERENT NEURON

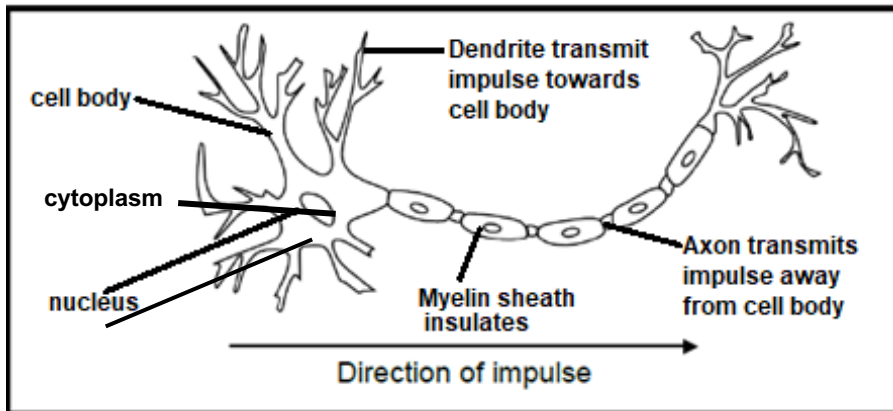

## 2. SENSORY NEURON/ AFFERENT NEURON

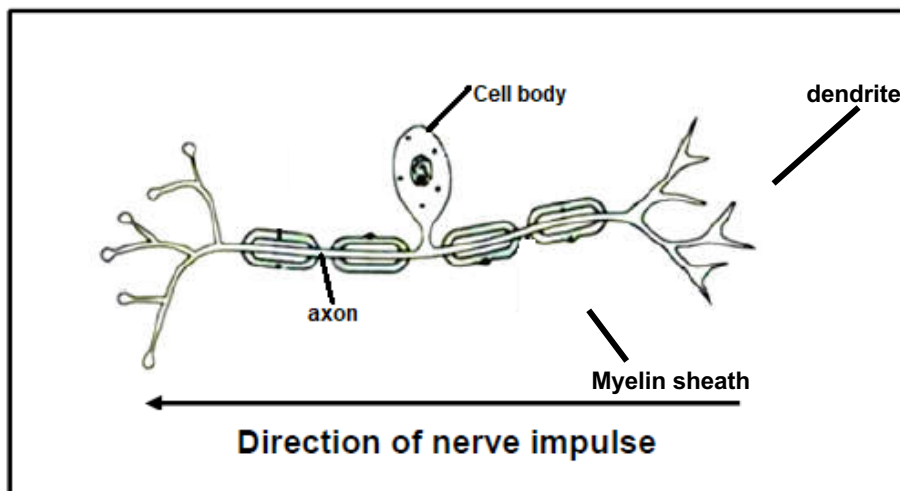



### 3. INTERNEURON

(STRUCTURE NOT REQUIRED FOR EXAM PURPOSES)

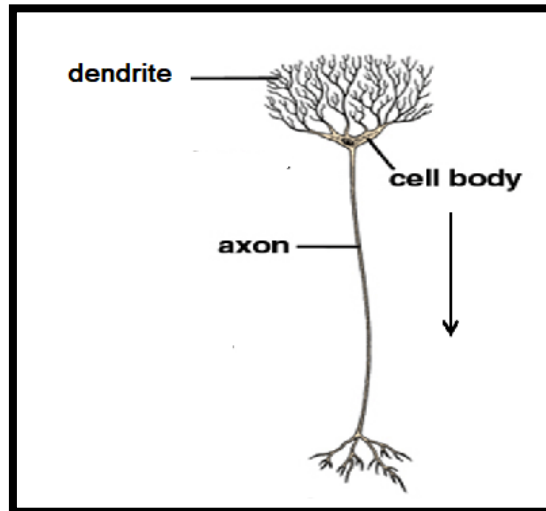

*Remember: the impulse moves from the dendrites to the cell body and then to the axon*

## REFLEX ARC

**Labels: Know only:** Receptor, Sensory neuron, Dorsal root of spinal nerve, Spinal cord, Interneuron, Motor neuron, Ventral root of spinal nerve, Effector

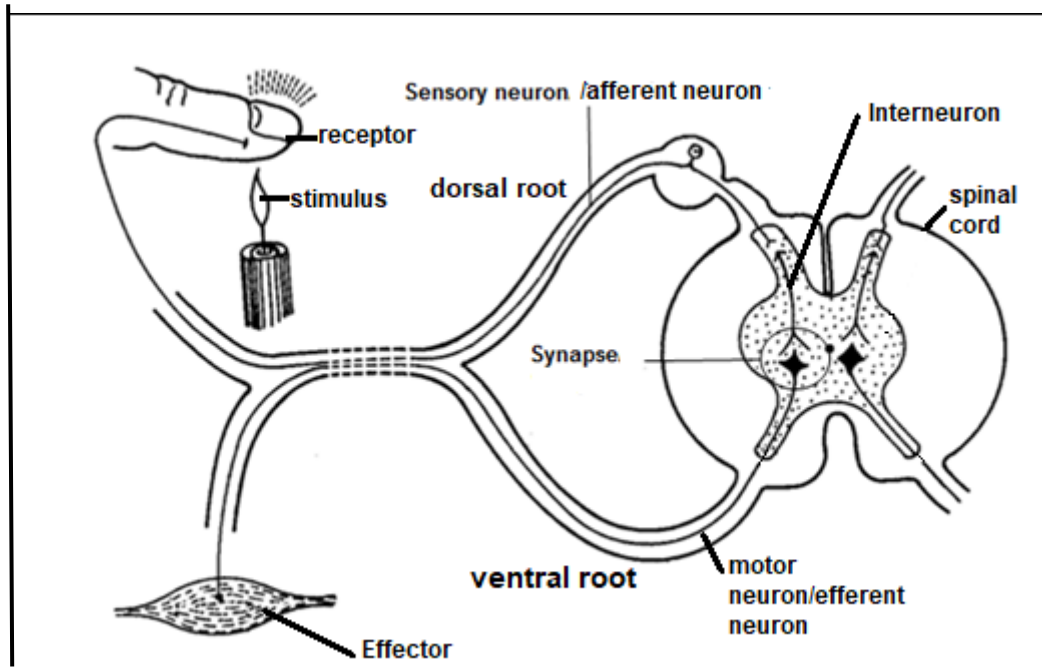

- A **reflex action** is a quick, automatic response to a stimulus.  
Examples: knee-jerk, sneezing and quickly removing a body part away from danger, to prevent further damage.
- A **reflex arc** is the pathway along which an impulse is transmitted to bring about a response to a stimulus during a reflex action.

## The autonomic nervous system

- The autonomic nervous system (ANS) controls the heart rate, breathing, digestion and gland functions e.g. salivary glands secreting saliva
- The autonomic nervous system has two branches
- The **sympathetic branch** prepares the body for emergency situations (flight or fight response) where a burst of energy would be required.
- The **parasympathetic branch** is active under ordinary, restful conditions.
- The two systems have an opposite effect: one stimulates, the other inhibits i.e. each organ in the body is innervated by the sympathetic nerve and parasympathetic nerve
- This is known as double innervation
- E.g. the sympathetic nerve causes the radial muscles to contract thus dilating the iris and the parasympathetic nerve causes the circular muscles to contract thus constricting the iris.

SYMPATHETIC BRANCH	PARASYMPATHETIC BRANCH
1. Increases heart rate	1. Decreases heart rate
2. Relaxes walls of bladder	2. Contracts wall of bladder
3. Dilates pupils	3. Constricts pupils
4. Constricts arteries of the digestive system and skin	4. Dilates arteries of the digestive system and skin
5. Increases blood pressure	5. Decreases blood pressure

## Illnesses of the nervous system:

### Alzheimer's disease

- Usually affecting people over 65, although some people may develop early-onset of this disease
- Characterized by a loss of neurons and synapses in the cortex of the brain, as well as the presence of clumps of proteins (amyloid plaques) and tangled bundles of fibres.
- The main symptoms are memory loss and confusion.

### Multiple sclerosis

- Damage to the axon-coating myelin sheath of nerve cells in communication pathways.
- Scattered patches of demyelination in the pathways make it impossible for messages to move across these hard areas.
- Cause: Auto-immune disease
- Symptoms: (negative effects)
  - Difficulty in walking
  - Loss of speech and vision
  - Fatigue
  - Bladder and bowel problems
  - Pain
  - Concentration and memory loss
  - Mood swings

## EXAM TIPS: BRAIN, NEURONS, REFLEX ARC

The following tips have been extracted from the Life Sciences Diagnostic Reports for the last 4 years

- Spelling is very important, if you spell the term incorrectly you will not be rewarded a mark.
- Know ALL the relevant labels for the diagrams of the Brain, Spinal cord, Reflex arc and Neurons. See the reminders with the diagrams given.
- You MUST be able to draw the different types of neurons so revise your Gr 10 work on Mammalian tissues!
- **Do not talk about messages being transmitted**, they are **nerve impulses**

The following terms/ structures are often confused. Know the difference between each:

- **Cerebrum and cerebellum:**
  - The significant **difference between cerebellum and cerebrum** is their size.
  - The **cerebrum** is the largest part of the brain, and it contributes nearly 80% of the total weight of the human brain. The **cerebrum** controls voluntary movement, intelligence and memory.
  - The **cerebellum** makes up the remaining part of the brain and is responsible for:
    - human voluntary actions to make smooth and precise movement possible: running, walking, jumping, and coordinating our eye movements.
    - control of muscle tone to maintain balance and posture.
- **Corpus callosum and corpus luteum** are often confused.
  - Corpus callosum (Latin, meaning “tough body”) is a wide, thick nerve tract, beneath the cerebral cortex in the brain
  - Corpus luteum (Latin, meaning “yellow body”) is a yellow mass of tissue that forms from a mature ovarian follicle after ovulation and which secretes progesterone.
- **Sensory, Motor and Interneurons:**
  - **Sensory:** these are afferent neurons: conduct nerve impulses from receptors to the central nervous system (CNS) and are unipolar
  - **Motor:** these are efferent neurons: conduct nerve impulses from the CNS to the effectors) and are multipolar
  - **Interneurons:** these are connector neurons: connect sensory and motor neurons in the CNS and are bipolar
- **Reflex action and a Reflex arc**
  - **Reflex action** is an **involuntary action** by the body generated by the body in response to the environment.
  - **Reflex arc** is a **neural pathway** along which an impulse is transmitted to bring about a response to a stimulus during a reflex action

- **Receptors and Effectors**
  - **The receptor:** detects the stimulus and converts it into a nerve impulse that is transmitted via the nerve to the **brain**
  - **The effector:** is a muscle or gland that responds accordingly to the nerve impulse received

## PRACTICE QUESTIONS: THE BRAIN

### THE BRAIN

#### QUESTION 1

The structure below is a human brain

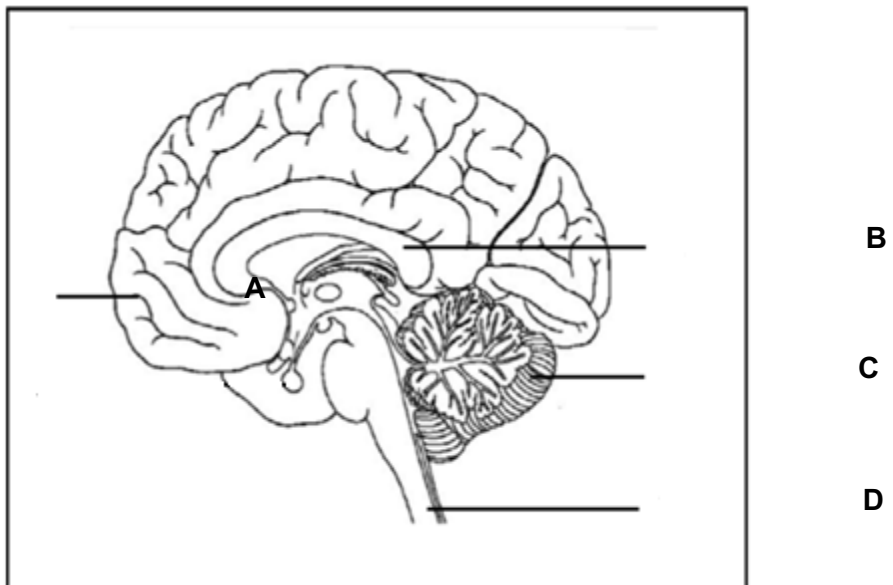

Give the LETTER and NAME of the part of the brain responsible for:

- 1.1 **Memorising a mobile phone number:** (2)  
A ✓ - Cerebrum ✓
- 1.2 **Coordinating all voluntary movements** (2)  
C ✓ - Cerebellum ✓
- 1.3 **Connecting the two hemispheres of part A** (2)  
B ✓ - Corpus callosum ✓
- (6)

## QUESTION 2

Describe the path of an impulse in a reflex arc during a reflex action

(8)

- The receptor receives the stimulus ✓
- and converts it into an impulse ✓
- which is transmitted by the sensory neuron ✓
- through the dorsal root ✓ of the spinal nerve to the spinal cord ✓
- where the impulse is transferred via the interneuron ✓
- to the motor neuron ✓
- which carries the impulse via the ventral root ✓
- to the effector ✓ / muscle / gland
- The impulse is transferred from one neuron to the next via a synapse ✓ (Any 8)

## QUESTION 3

The diagrams below show different neurons

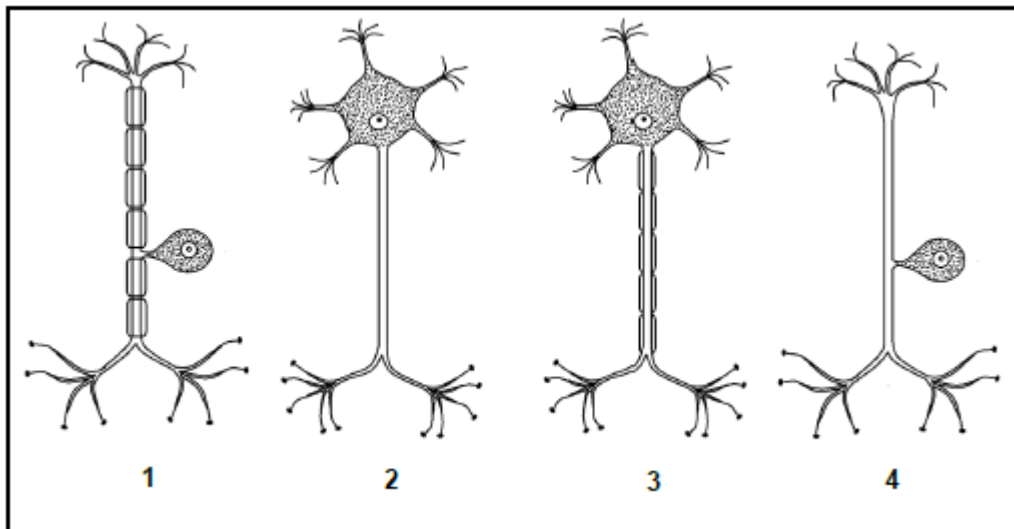

3.1 Give the NUMBERS (1, 2, 3 or 4) of TWO neurons that:

(a) transport impulses from the receptor to the central nervous system

(2)

*Remember RSIME: Receptor, Sensory neuron, Inter-neuron, Motor neuron, Effector!  
The sensory neuron is the one you are looking for.*

(a) diagrams 1 ✓ and 4 ✓

(b) will have a faster transmission of impulses

(2)

*Remember that speed is dependent on an insulated axon.*

*Only diagrams 1 and 3 have the protective myelin sheath around the axon*

(b) Diagrams 1 ✓ and 3 ✓

(4)

## TERMINOLOGY: HUMAN EYE

BIOLOGICAL TERM	DESCRIPTION
<b>Accommodation</b>	The ability of the lens of the eye to alter its shape for clear vision when viewing both near and distant objects
<b>Astigmatism</b>	Uneven curvature of the lens or cornea resulting in distorted images
<b>Aqueous humour</b>	The watery fluid that supports the cornea and the front chamber of the eye
<b>Long-sightedness</b>	Disorder of the eye where a person can clearly see objects far away but objects close by are blurred; this is caused by a lens that cannot become more convex/ rounded enough to refract light, so the image falls behind the retina
<b>Short-sightedness</b>	Disorder of the eye where a person can clearly see objects close by but objects that are far away are blurred; this is caused by a lens that is too rounded/ convex, so the image falls short of the retina
<b>Optic nerve</b>	The nerve that carries impulses from the retina to the brain
<b>Photoreceptors</b>	Specialized receptors to receive the stimulus of light and convert it to an impulse. There are two types of photoreceptors in the retina of the eye called rods and cones
<b>Refraction</b>	To bend light – refraction takes place when light passes through a lens that is bent by a <b>convex</b> [ ( ) ] shape or a <b>concave</b> [ )( ] shape
<b>Retina</b>	Innermost membrane in the eye that contains photoreceptors
<b>Binocular vision</b>	Vision using two eyes with overlapping fields of view so that the separate images are combined and interpreted as one image by the brain.
<b>Stereoscopic vision</b>	The ability to form three dimensional images which provides the ability to judge distance, depth and the size of an object.

## LONGITUDINAL SECTION OF THE EYE

Know ALL the labels for the structure of the Human Eye

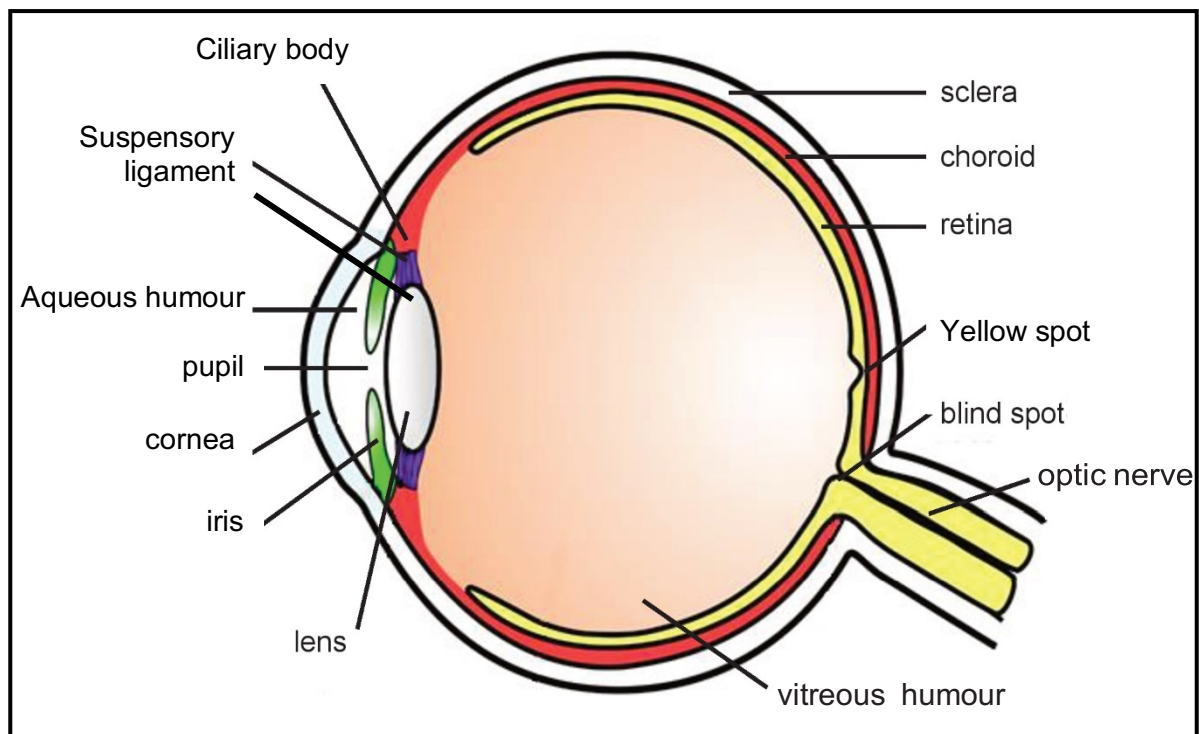

### Functioning of the Eye – path of light

- The eyes are organs that make it possible for us to see images.
- Light rays pass from an object to the **eye**, and are refracted by the transparent convex **cornea**, **aqueous humour**, the **biconvex lens** and **vitreous humour**.
- As the light rays pass through the curved surfaces of the cornea and the lens, **light is refracted** (bent).
- The lens refracts the light rays and forms an **inverted** (upside-down) image on the retina, bringing the image into focus by making fine adjustments.
- The **rod and cone cells** (photoreceptors) are stimulated by the light rays and convert the stimuli into impulses.
- These impulses are transmitted along the **optic nerve** to the **cerebrum**.
- The impulses are interpreted as an upright image of particular size, shape and colour.



## Accommodation:

The eyes can change the convex curve of the lens and therefore the focal length. This process is termed **accommodation**. This allows us to clearly see objects close by and far away. Refer to the diagram below as well as an explanation from the **DBE Life Sciences**

Gr 12 Textbook page 172 - 173

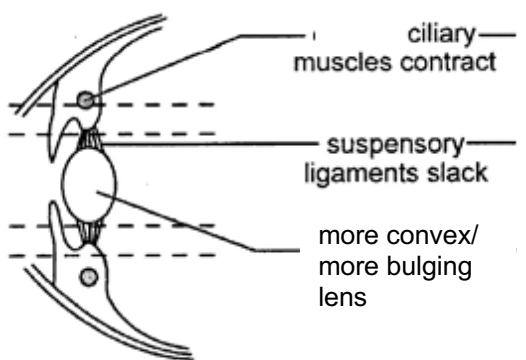
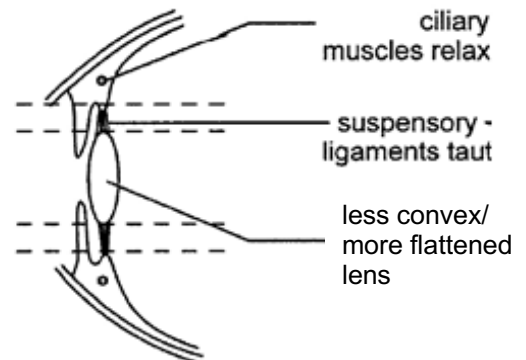
Near vision (more convex/rounded lens) Viewing an object <b>closer than 6 metres</b>	Distant vision (less convex/flatter lens) Viewing an object <b>further than 6 metres</b> away.
1. Ciliary muscles <b>contract</b> (these muscles are circular)	1. Ciliary muscles <b>relax</b>
2. Suspensory ligaments <b>slacken</b>	2. Suspensory ligaments tighten (become taut)
3. Tension on the lens <b>decreases</b>	3. Tension on the lens <b>increases</b>
4. Lens becomes <b>more convex</b> and <b>rounded</b>	4. Lens becomes <b>less convex</b> and <b>flatter</b>
5. Light rays are <b>more</b> refracted (bent)	5. Light rays are <b>less</b> refracted (bent)
6. Light rays are focussed onto the retina (yellow spot)	6. Light rays are focussed onto the retina (yellow spot)
 <p><b>Side view</b></p>	 <p><b>Side view</b></p>

### Pupillary mechanism / Pupillary reflex action:

- The pupillary mechanism is a reflex action regulated by the Autonomic Nervous System, to regulate the amount of light passing into the eye at any one time.
- The **intensity of the light** is the stimulus that changes the size of the pupil.
- The **circular and radial** muscle fibres in the iris regulate the size of the **pupil**.
- The **iris** functions to control the amount of light that enters the eye by controlling the size of the pupil.

Refer to the diagram below as well as the **DBE Textbook page 173**

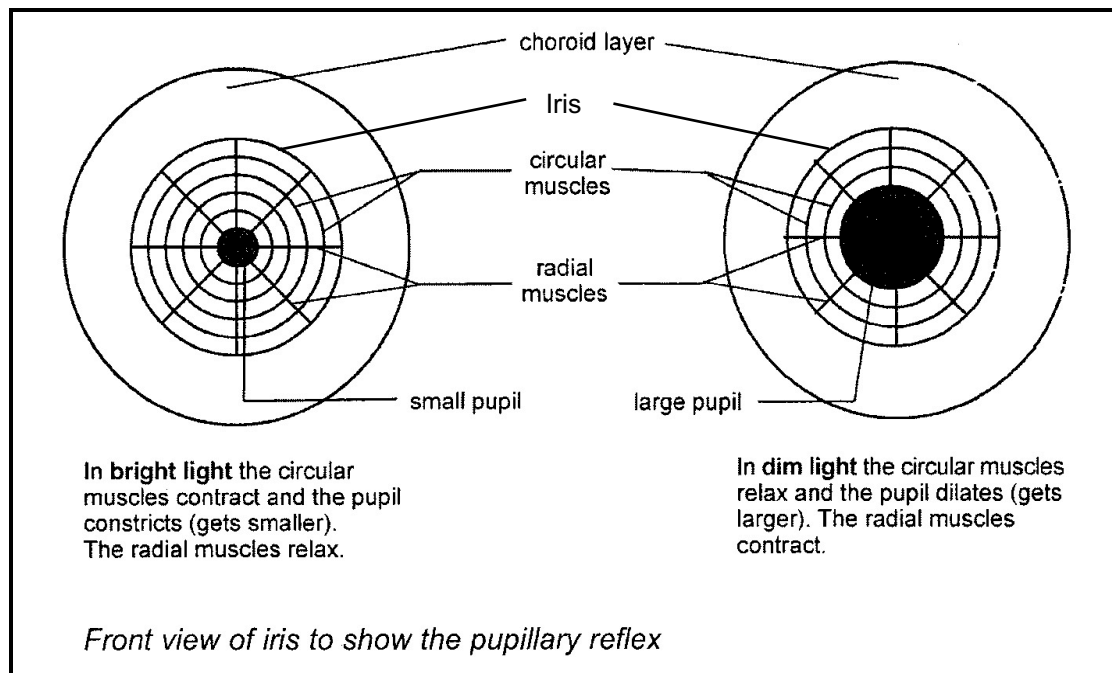

## VISUAL DEFECTS:

### Astigmatism

- This is an optical defect that results in blurred vision.
- It is caused by an **irregular curvature** of the cornea or the lens,
- so the eye has **different focal points** that occur in different planes.
- Glasses and hard contact lenses correct the irregular focal points.

### Cataracts

- This is the **clouding** of the lens
- (like light coming through a frosted glass window, the image is blurred)
- when the lens cortex liquefies to form a milky white fluid.
- Cataracts progress over time and may result from:
  - long-term exposure to ultra-violet light
  - radiation
  - diabetes
  - hypertension
  - old age
  - physical trauma
- Cataracts must be removed surgically
- Extra-capsular surgery (ECCE) is used
- and the lens is replaced with a **plastic lens**

### Short-sightedness

- This is also called near-sightedness.
- It is a refractive defect where the image focuses **in front** of the retina
- because the cornea is **too rounded**.
- Distant objects are seen as blurred.
- Glasses and contact lenses that are concave [()](
- are prescribed to **reduce refraction**.

### Long-sightedness

- This is also called far-sightedness.
- This is a refractive defect where the image focuses **behind** the retina.
- The person will see objects as blurred images when they are close by
- This is corrected by using convex lenses [()].
- This condition is caused by an eyeball that is **too short** (genetic)
- or the lens **cannot become round** enough.

Refer to DBE textbook page 175.

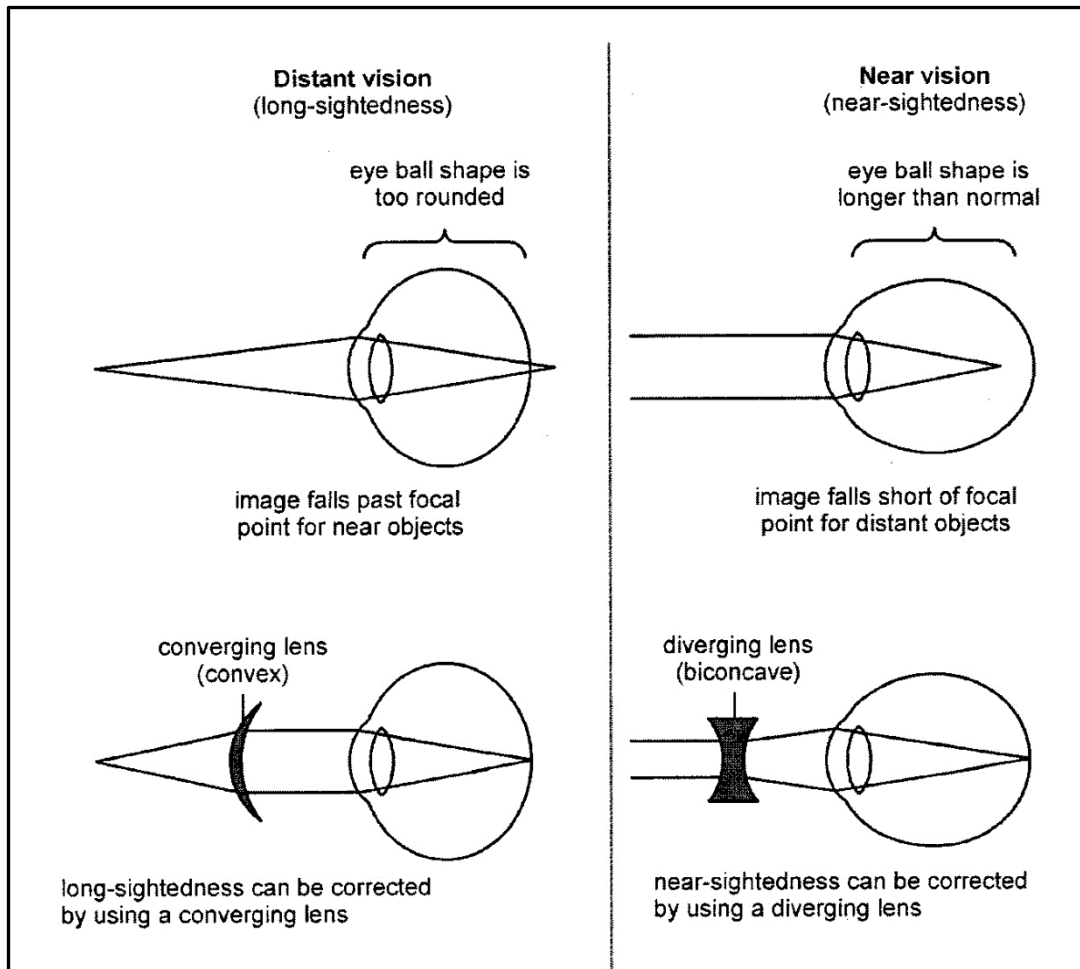

## EXAM TIPS: HUMAN EYE

The following tips have been extracted from the Life Sciences Diagnostic Reports for the last 4 years and apply specifically to the topic of the human Eye.

The following concepts and structures are regularly confused and misunderstood:

Use the table below to understand the difference between accommodation and pupillary mechanism, as these two concepts are often confused.

- The first step is to ensure that you can name the parts of the eye that are responsible for each process whilst also identifying these structures in a diagram of the eye.

	Accommodation	Pupillary mechanism
<b>Stimulus</b>	- Change in distance of object from the eye	- Change in light intensity
<b>Parts involved</b>	- Lens - Suspensory ligaments - Ciliary muscles	- Pupil - Radial muscles of iris - Circular muscles of iris
<b>Main change that must take place</b>	- Shape of lens	- Diameter of pupil
<b>What brings about the change above</b>	- Suspensory ligaments - Ciliary muscles	- Radial muscles of iris - Circular muscles of iris

Make sure you revise the difference between:

- distant and near vision
- constrict and contract
- convex and concave lenses
- long-sighted and short-sighted

The words taut, slack, relaxed, are often incorrectly used:

- E.g. Ligaments cannot contract or relax, they are either taut or slack.
- Only muscles can contract and relax

Also ensure that you:

- can link the *structure* of the lens with its specific *function*.
- have sufficient knowledge on visual defects
- can suggest corrective treatment for the different visual defects
- can perform basic calculations: on proportion for a pie-chart; in drawing the pie-chart **OR** the calculation for percentage increase.
- can use mathematical instruments (a protractor and compass) for the drawing of a pie chart

## PRACTICE QUESTIONS: HUMAN EYE

### QUESTION 1

The diagram below represents the structure of the human eye.

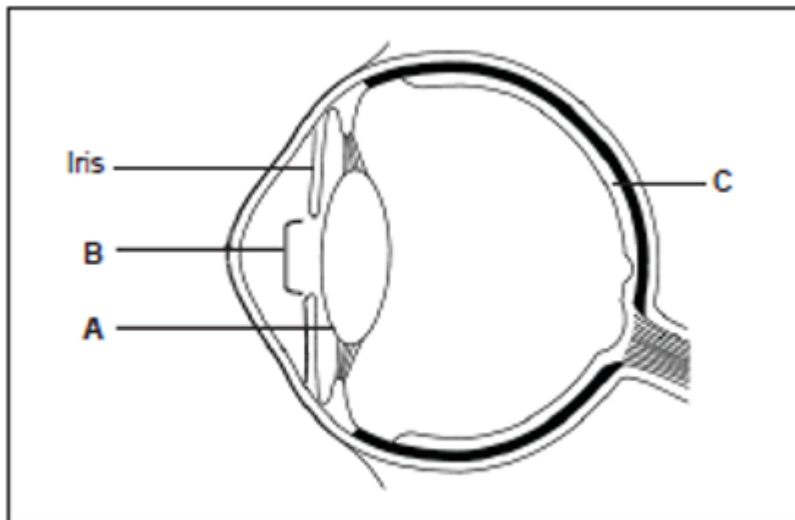

1.1 State ONE function of part:

(a) **A** (1)

-Refraction of light ✓

-Focus light rays on the retina ✓

(Any 1)

(b) **C** (1)

-Converts light stimuli to impulses ✓

-Forms images ✓

(Any 1)

1.2 Describe how the iris controls the amount of light entering the eye when a person is exposed to bright light. (4)

*Remember that this is the pupillary mechanism*

-The radial muscles of the iris relax ✓

-Circular muscles of the iris contract ✓

-The pupil constricts ✓

-Less light enters the eye ✓

**1.3 Nocturnal animals sleep during the day and are active at night,**

**Explain how part:**

**(a) B of nocturnal animals will differ from that found in animals that are active during the day (2)**

*Remember: these are animals that can see very well at low light intensities (in the dark). What will help them to get the maximum amount of light into the eye?*

- The pupil/ part B can dilate more ✓ (*statement*)
- To allow more light to enter the eye ✓ (*reason*)

**(b) C of nocturnal animals will differ from that found in animals that are active during the day. (2)**

*In order to see better in low light intensity, they will need more receptors that will detect light and dark and shades of grey: the rods*

- The retina/ part C has more rods ✓ (*statement*)
- enabling them to see in dim light ✓ (*reason*)

**QUESTION 2**

**Describe the accommodation of the eye for distant vision. (5)**

*Remember to read the question carefully, your description is for a DISTANT object.*

- The ciliary muscle is relaxed ✓
- The ciliary body/ choroid layer moves backward/ away from the lens ✓
- The suspensory ligaments are tight/ taut ✓
- Tension on the lens is increased ✓
- The lens is less convex/flatter ✓
- Light rays are refracted less ✓
- A clear image falls on the retina/ yellow spot ✓ (Any 5)

## TERMINOLOGY: HUMAN EAR

BIOLOGICAL TERM	DESCRIPTION
<b>Auditory Canal</b>	The open passage through which sound waves travel to the middle ear.
<b>Auditory Nerve</b>	A bundle of <b>nerve</b> fibres that carries impulses between the cochlea and the brain.
<b>Cristae</b>	Receptors within the ampullae of the semi-circular canals which detect changes in speed and direction of the head
<b>Cochlea</b>	Spirally coiled, fluid-filled structure of the inner ear responsible for the detection of pressure waves which are converted to impulses that are transmitted to the brain.
<b>Eardrum/Tympanum</b>	A taut, circular piece of skin that vibrates when hit by sound waves.
<b>Eustachian Tube</b>	The passageway that connects the ear to the back of the nose to maintain equal air pressure on both sides of the eardrum.
<b>Grommets</b>	Small tubes placed in the tympanum to drain moisture from the middle ear
<b>Maculae</b>	Receptors in the sacculus and utriculus which detect changes in the position of the head/ with respect to gravity
<b>Ossicles</b>	Three little bones called the hammer, anvil and stirrup located in the middle ear and that function to amplify sound.
<b>Pinna</b>	The outer portion of the external ear: sound travels through the outer wear to the ear canal.
<b>Semi-circular Canals</b>	Fluid-filled structures in the inner ear that detect movement and function as balance organs.



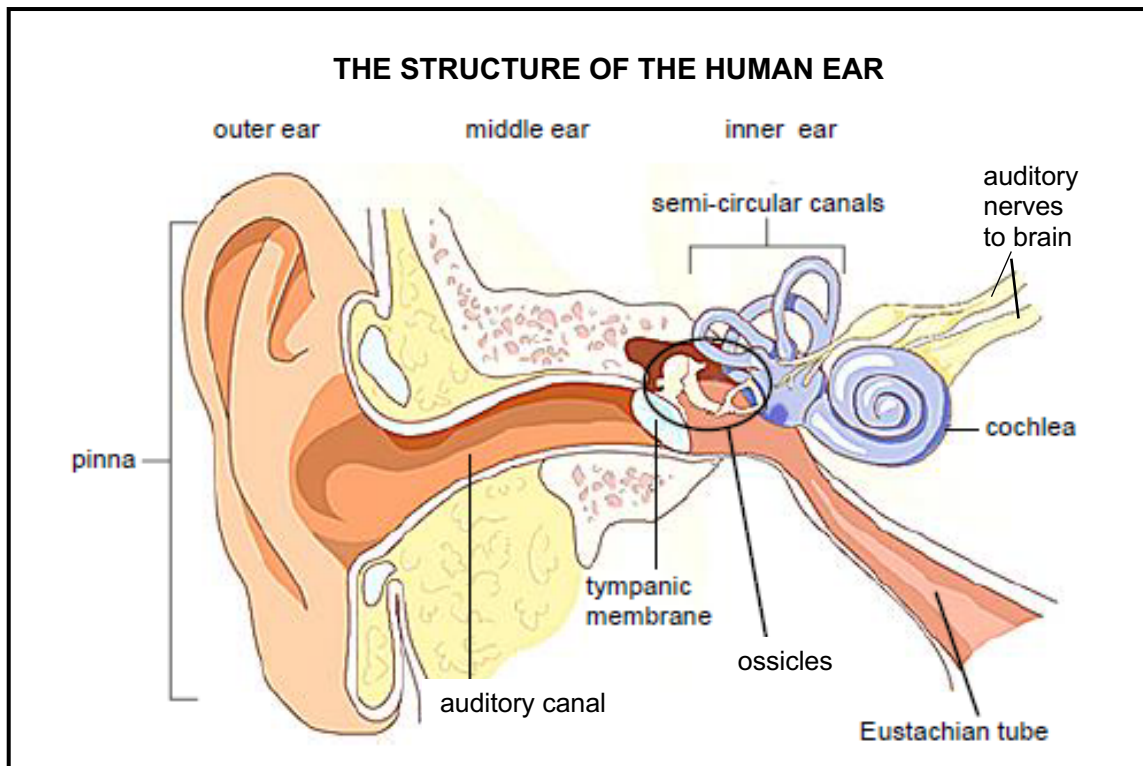

Remember the following pathway of stimuli in the process of Hearing

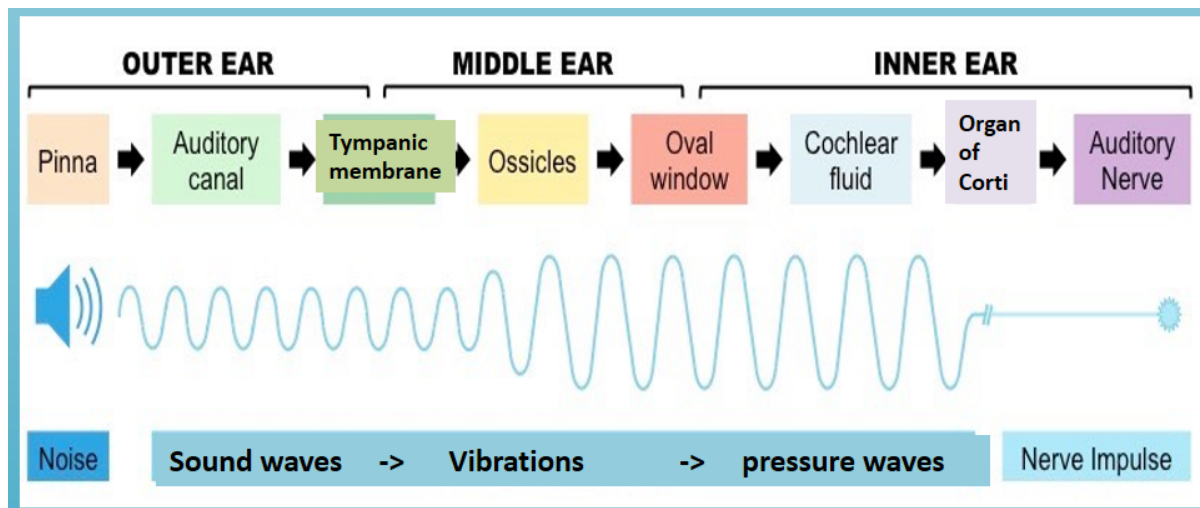

#### Function of the Eustachian tube

- Connect the middle ear with the throat.
- Excess fluid from middle ear drains into throat.
- **Equalises pressure** on **either side** of the **tympanic membrane**.

#### Function of the Eustachian tube when flying:

- The higher you go the less the air pressure becomes. (Higher altitude; less air pressure).
- The pressure in the auditory canal becomes less than the pressure inside the middle ear.
- Tympanic membrane experiences greater pressure from the middle ear's side.
- Air needs to leave middle ear via Eustachian tube to equalise the pressure on both sides of the tympanic membrane. Yawning will help with the equalisation.

### Function of the Eustachian tube when Scuba diving

- The deeper you dive the higher/greater the water pressure becomes.
- Water exerts pressure on the tympanic membrane, because pressure inside the auditory canal is higher than the pressure in middle ear.
- You have to close your nose and blow so that air is forced into middle ear via the Eustachian tube.
- In this manner air pressure is equalised on both sides of the tympanic membrane.

### Balance:

The human ear is responsible for maintaining balance.

- The semi-circular canals each have a swelling called the **ampulla**. The ampulla contains receptors called **crista**. When there is a change in speed or direction, the cristae are stimulated, and the stimulus is converted into a nerve impulse. This impulse is transmitted along the auditory nerve to the **cerebellum** where it is interpreted. The cerebellum will send impulses to the muscles, to restore balance.
- The **sacculus and utriculus** contain sensory hair cells called **maculae**. When the head position changes, the **pull of gravity** stimulates the maculae, which convert the stimulus into an impulse, which is transmitted along the auditory nerve to the **cerebellum** where it is interpreted. The cerebellum will send impulses to the muscles, to restore balance.

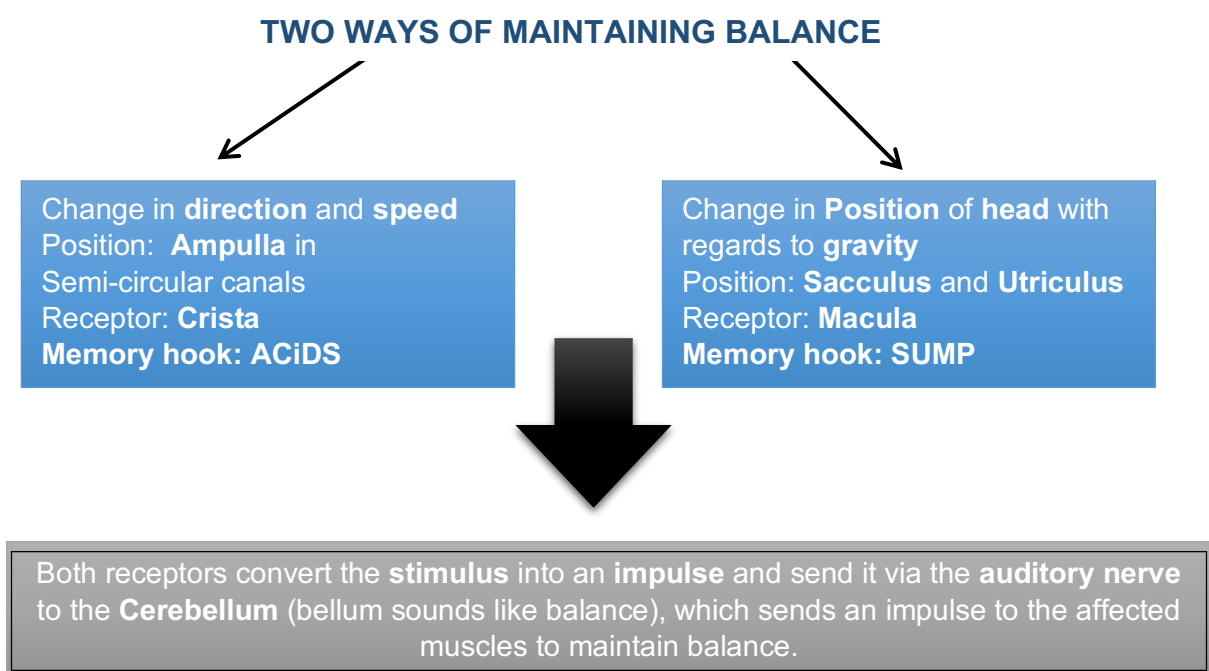

Ear Hearing defect:	Causes:	Treatment:
<b>Middle ear infection</b>	<ul style="list-style-type: none"> <li>Middle ear becomes infected by bacteria.</li> <li>Pressure builds up (pus and excess fluid) in the middle ear behind the ear drum, causing <b>extreme pain, and hearing loss</b> (because the eardrum cannot vibrate freely)</li> </ul>	<ul style="list-style-type: none"> <li>Inserting grommets (allows excess fluid to drain from middle ear)</li> <li>Antibiotics</li> </ul>
<b>Deafness</b> (‘hearing impairment’, ‘hard of hearing’ or ‘deafness’)	<ul style="list-style-type: none"> <li>Injury to parts of the ear, nerves or parts of the brain.</li> <li>Hardened wax collected in the auditory canal</li> <li>Hardening of ear tissue like around ossicles</li> </ul>	<ul style="list-style-type: none"> <li>Hearing aids (amplify sounds)</li> <li>Cochlear implants (stimulates the auditory nerves with an electronic field, inside the cochlea)</li> </ul>

## EXAM TIPS: HUMAN EAR

The following tips have been extracted from the Life Sciences Diagnostic Reports for the last 4 years and apply specifically to the topic of the human ear.

- Read the question carefully. Make sure you read every sentence before grabbing your pen to start writing.
- Learn the correct biological terminology and not the common names e.g., *impulse* instead of *message*.
- Make sure that you know the difference between vibrations, pressure waves, sound waves, and impulses.
- Also make sure you can differentiate between the roles of the cerebrum in hearing and the cerebellum in balance in the functioning of the ear.
- The process of balance:**
- you need to clearly understand the separate role of the cristae and maculae so that you can:
  - give both aspects if a general account on balance is required
  - give the relevant part when only one aspect is asked for.
- When a **receptor** is stimulated, the stimulus is converted into an **impulse** that is transmitted through the vestibular branch of the **auditory nerve** to the **cerebellum**. Here the impulse is **interpreted**, and **impulses are sent** to the **muscles** of the body (the **effectors**) to restore balance.

- **The process of hearing:** In the Cochlea of the ear, it is a **pressure wave** that stimulates the **Organ of Corti** to convert the stimulus into a nerve impulse.
- When answering questions based on predicting the effect of a part, such as the oval window when it fails to function, a successful answer depends on:
  - knowing the function of the structure.
  - Then it is easy to deduce what would happen if that function was not performed.
- If you have to answer a question requiring an explanation, you will have to apply your knowledge of the content.

**Explain why fusion of the structures at A (ear ossicles) may lead to hearing loss.**

- The first step is to **identify part A** (ossicles).
- The next step is to be able to **identify its function** (transmits vibrations to the oval window/amplifies sound).
- **Identify the special case mentioned in this question** (The ossicles are fused).
- **What is the consequence of the ossicles being fused?** (They cannot vibrate).

## PRACTICE QUESTIONS: HUMAN EAR

### QUESTION 1

Study the diagram below

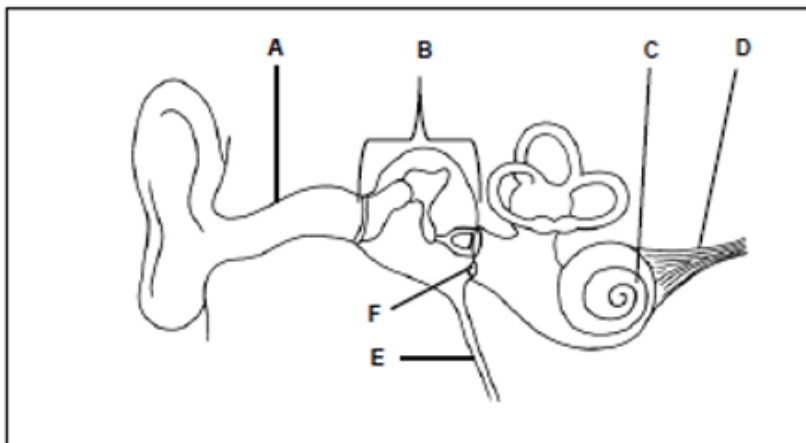

- 1.1 Give ONE function of part:**
- (a) **A** (1)  
*A is auditory canal*  
 Transmits sound waves to the tympanic membrane ✓
- (b) **E** (1)  
*E is Eustachian tube, connecting the middle ear and the throat*  
 Equalises pressure on either side of the tympanic membrane ✓
- (c) **F** (1)  
*F is the round window, which vibrates to get rid of excess movement in the fluid (endolymph) in the inner ear*  
 Releases pressure from the inner ear ✓
- 1.2 Write down the LETTER of the part where sound is transmitted in the form of:**
- (a) **A pressure wave in a liquid** (1)  
*What is a pressure wave?*  
*Noise → sound waves → vibrations → pressure waves → nerve impulse*  
*Labels            A                    B                    C                    D*  
 C ✓
- (b) **An electrical impulse** (1)  
*What is an electrical impulse? A nerve impulse*  
 D ✓
- 1.3 Explain the effect if the receptors in region C are damaged** (3)  
*Explanation: requires a statement and a reason or cause and effect*  
 -The receptors cannot convert the stimuli into impulses ✓ (*cause*)  
 -No impulses/ fewer impulses are transmitted to the cerebrum ✓ (*effect*)  
 -and the person does not hear anything ✓/hearing is impaired (*effect*)
- 1.4 Describe how the parts of the middle ear, including the membranes, assist with amplifying sounds.** (3)  
*Amplifying = increasing/ making bigger, louder. This is zooming in on the middle ear: the tympanic membrane, ossicles and oval window*  
 -The sound vibrations are transmitted from the large tympanic membrane ✓  
 -through the ossicles ✓  
 -Which are arranged from largest to smallest ✓  
 -to the smaller oval window ✓  
 -This concentrates the vibrations, ✓ amplifying them (Any 3)

**1.5 Describe the role of the semi-circular canals in maintaining balance.**

**(4)**

*A description is a stepwise account of the process.*

Part of ear	Receptors	Stimulus
<i>Semicircular canals</i>	<i>Cristae</i>	<i>Changes in speed and direction</i>
<i>Sacculus and utriculus</i>	<i>Maculae</i>	<i>Changes in the position of the body</i>

- A change in the speed/ direction of movement ✓ *of the endolymph/ fluid*
- stimulates the cristae ✓ *NOT the Maculae*
- The stimulus is converted into an impulse ✓ *Not a message*
- The impulse is transmitted via the auditory nerve ✓
- to the cerebellum ✓ *not brain or cerebrum*
- The cerebellum sends impulses to the muscles ✓ *to restore balance*

**(15)**

## QUESTION 2

The diagrams below show different parts of the brain and the ear.

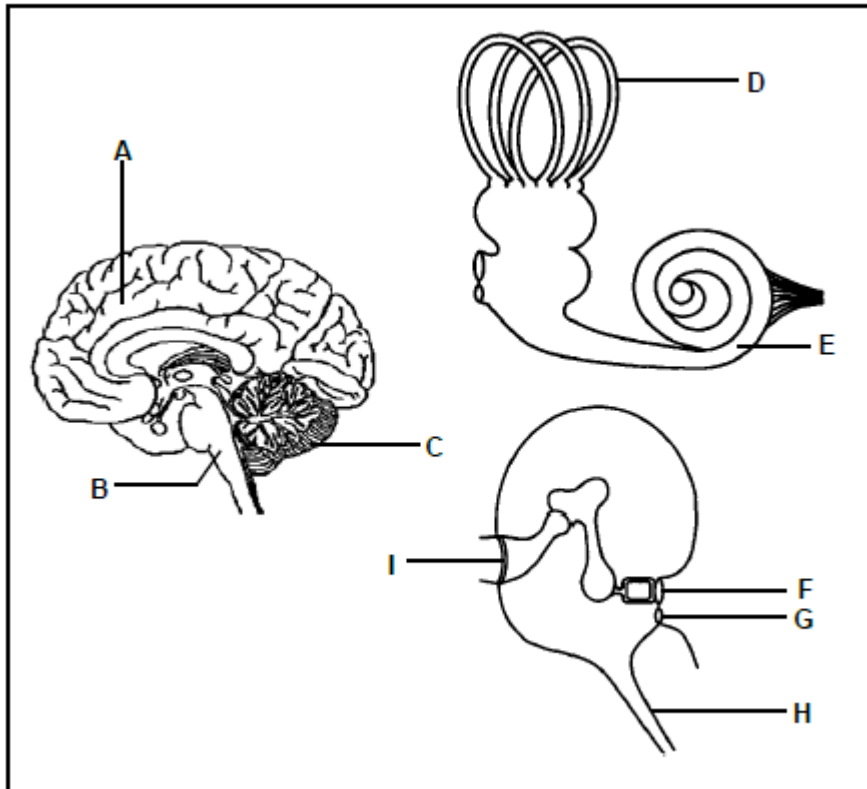

### 2.1 Identify part:

- (a) **A** (1)  
*This is in the diagram of the brain, largest portion*  
Cerebrum ✓
- (b) **B** (1)  
*This is the top part of the spinal cord, the medulla oblongata*  
Medulla oblongata ✓
- (c) **H** (1)  
*This is in the EAR and is the tube that connects the middle ear with the throat*  
Eustachian tube ✓

### 2.2 Give the LETTER and NAME of the part of the ear that absorbs excess pressure waves from the inner ear (2)

- This is the round window, G, which vibrates to get rid of excess movement in the fluid (endolymph) in the inner ear*  
G ✓ Round window ✓

**2.3 Name the receptors found at part E (1)**

*E is the cochlea and contains the hair cells of the organ of Corti*

Hair cells✓ / Organ of Corti

**2.4 Explain why damage to part B can lead to instant death (2)**

*B is the medulla oblongata, the brain stem. Severing the brain stem will bring about instant death because the pathway for impulses to all the vital organs, has been disrupted and vital processes like the heartbeat, breathing cannot take place*

Part B controls vital processes✓/ heartbeat/ breathing

These processes will stop✓ leading to death

**2.5 Describe how part C responds to impulses received from part D (3)**

*Imagine that you have been spinning yourself around to make yourself dizzy. The endolymph in the semi-circular canals (Part D) is moving at quite a speed. This stimulates the cristae, which then generate impulses which are transported to the cerebellum (Part C), via the auditory nerve. The cerebellum will in turn send impulses to the muscles to correct/ restore balance and stop you from falling down.*

-The impulses will be interpreted ✓by the cerebellum *not brain or cerebrum*

-and impulses will be sent to the skeletal muscles✓

-to restore/ maintain balance✓

**2.6 In older people, part F of the ear may harden. Explain how this condition may lead to hearing loss (4)**

*-Don't give the function of F but rather explain what will happen if it doesn't work anymore*

-The oval window/ Part F will not vibrate ✓freely

-Fewer/ no vibrations will be carried to the cochlea✓/ inner ear

-Fewer/ no pressure waves will form ✓in the cochlea

-There will be less/ no stimulation of the organ of Corti ✓/ hair cells

-Fewer/ no impulses will be transmitted to the cerebrum ✓

-leading to hearing loss

**(15)**



## TYPICAL EXAM TYPE QUESTIONS

### QUESTION 1

Various options are provided as possible answers to the following questions.

Choose the correct answer and write only the letter (A to D) next to the question number

(1.1 to 1.10) in your ANSWER BOOK, for example 1.11 D.

- 1.1 Which part of the ear contains the receptors for hearing?
- A Cochlea
  - B Tympanic membrane
  - C Oval window
  - D Round window
- 1.2 Which ONE of the following is a consequence if the round window of the ear hardens?
- A Pressure waves will not be created.
  - B Impulses will not be transmitted to the brain.
  - C Pressure between the outer and the middle ear will not be equalised.
  - D An echo will occur, and the sound will be distorted.
- 1.3 Which part of the neuron transmits impulses towards the cell body?
- A Dendrite
  - B Myelin sheath
  - C Axon
  - D Synapse
- 1.4 A function of the iris of the eye is to ...
- A refract light to form a clear image.
  - B control the amount of light that enters the eye.
  - C convert the light stimuli into impulses.
  - D prevent reflection of light within the eye.
- 1.5 The vibrations of the tympanic membrane are transferred to the ...
- A ossicles and then the oval window.
  - B oval window and then the ossicles.
  - C ossicles and then the round window
  - D cochlea and then the ossicles
- 1.6 The nerve impulse in the axon of a sensory neuron is transmitted ...
- A towards the dendrite of the sensory neuron.
  - B towards the cell body of the sensory neuron
  - C away from the effector organ.
  - D away from the cell body.
- 1.7 Diagram A and diagram B below represent the same part of the same human eye under different conditions.

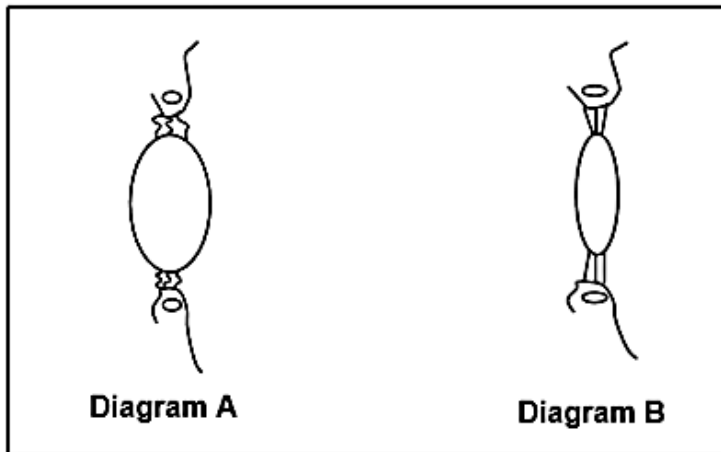

Which diagram, with a corresponding reason, represents a person looking at an object 10 metres away?

- A Diagram A because the suspensory ligaments are taut/tight, and the lens is less convex
- B Diagram A because the lens is more convex, and the suspensory ligaments are slack
- C Diagram B because the lens is more convex, and the suspensory ligaments are slack
- D Diagram B because the suspensory ligaments are taut/tight, and the lens is less convex

1.8 Which part of the ear converts pressure waves into nerve impulses?

- A Auditory nerve
- B Eustachian tube
- C Organ of Corti
- D Auditory canal

1.9 A person can feel pain in his legs but cannot move his legs.

This is a result of damage to the ...

- A sensory neuron.
- B sensory and motor neuron.
- C motor neuron.
- D sensory and interneuron

1.10 Colour vision is difficult at night, because under dim light conditions:

- A rods are not stimulated.
- B the pupil dilates.
- C cones are not stimulated.
- D the lens cannot change shape.

(10 x 2)

(20)

**QUESTION 2** (Questions taken from various sources)

Give the correct biological term for each of the following descriptions. Write only the term next to the question number (2.1 to 2.7) in your ANSWER BOOK.

- 2.1 The part of the brain that receives impulses from the maculae
- 2.2 The dark pigmented layer of the eye
- 2.3 The structure that connects the left and right hemispheres of the brain
- 2.4 The part of the brain that controls body temperature
- 2.5 The part of the nervous system made up of cranial and spinal nerves
- 2.6 The nerve that carries impulses from the retina to the brain
- 2.7 Collective name for the membranes that protect the brain and spinal cord
- 2.8 A disorder which results in the myelin sheath of the neurons being damaged

(8)

**QUESTION 3** (Questions taken from various sources)

Indicate whether each of the statements in COLUMN I applies to A ONLY, B ONLY, BOTH A AND B or NONE of the items in COLUMN II. Write A only, B only, both A and B, or none next to the question number (3.1 to 3.3) in the ANSWER BOOK.

COLUMN I		COLUMN II	
3.1	Condition affecting the cornea of the eye	A	Astigmatism
		B	Cataract
3.2	Only cones are present	A	Blind spot
		B	Yellow spot
3.3	Occurs in the iris in bright light	A	Radial muscles contract
		B	Circular muscles relax

(3 x 2) (6)

**QUESTION 4** (DBE, Nov. 2019, Paper 1)

The diagram below shows some parts of the human central nervous system

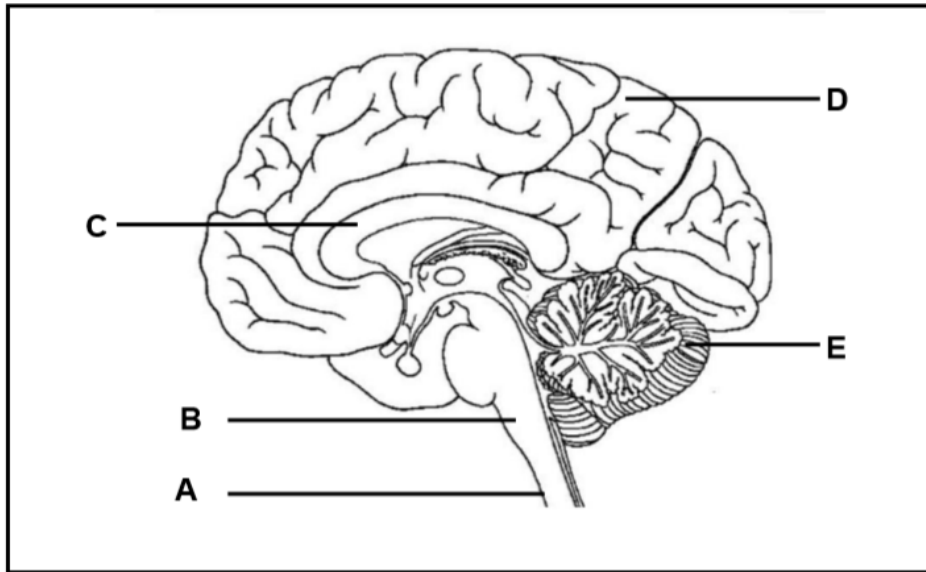

- 4.1 Identify part:
- (a) A (1)
  - (b) C (1)
- 4.2 Write down the LETTER and NAME of the part that:
- (a) Has the centre for interpreting taste (2)
  - (b) Regulates the heart rate (2)
  - (c) Is responsible for motor coordination (2)
- (8)**

**QUESTION 5** (DBE, Nov. 2019, Paper 1)

The table below indicates the percentage of visually impaired people in the world suffering from different visual defects.

VISUAL DEFECT	PEOPLE (%)
Blindness	2
Long-sightedness	64
Short-sightedness	30
Other	4

- 5.1 Which visual defect in the table is the most common among the world population? (1)
- 5.2 In some cases where people are blind, the condition is caused by cataracts.
- (a) Explain why people with cataracts may become blind. (1)
  - (b) State ONE way in which cataracts can be treated (1)
- 5.3 Explain why long-sighted people need to wear glasses with biconvex lenses as a corrective measure.

- 5.4 Name a visual defect that is characterised by an uneven cornea or lens. (1)
- 5.5 Draw a pie chart to represent the data in the table. (6)
- (15)**

**QUESTION 6** (DBE, FEB 2016, Paper 1)

The diagram below shows a reflex arc.

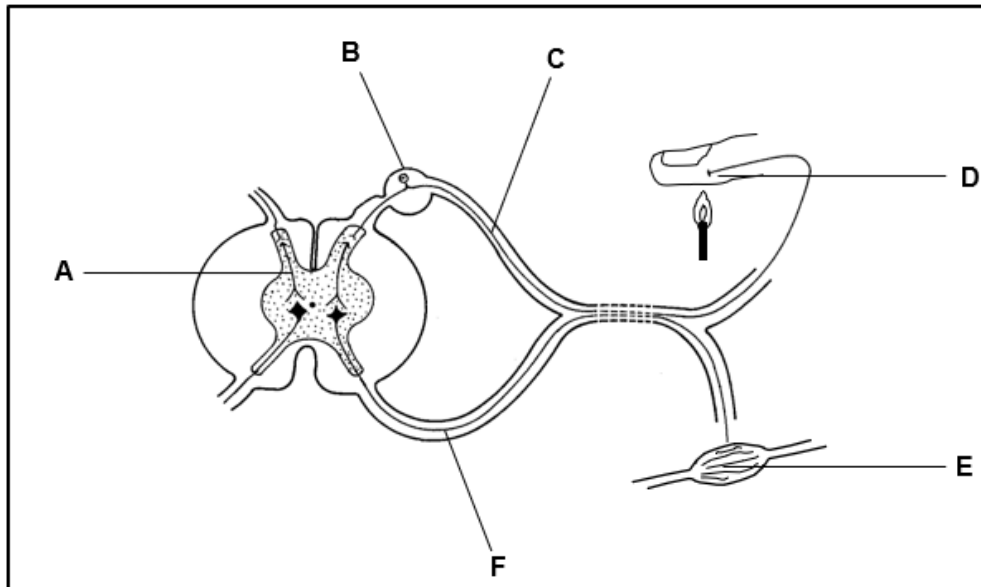

- 6.1 Give ONLY the LETTER of the part that represents the:
- (a) Effector (1)
  - (b) Interneuron (1)
  - (c) Sensory neuron (1)
- 6.2 Give the LETTER and NAME of the neuron in the diagram that is probably damaged if a person is able to detect the stimulus but cannot respond. (2)
- 6.3 State if the nerve impulse travels from D to E or from E to D. (1)
- (6)**

**QUESTION 7** (DBE, Nov. 2018, Paper 1)

Look at the diagram of the human ear below and answer the questions that follow:

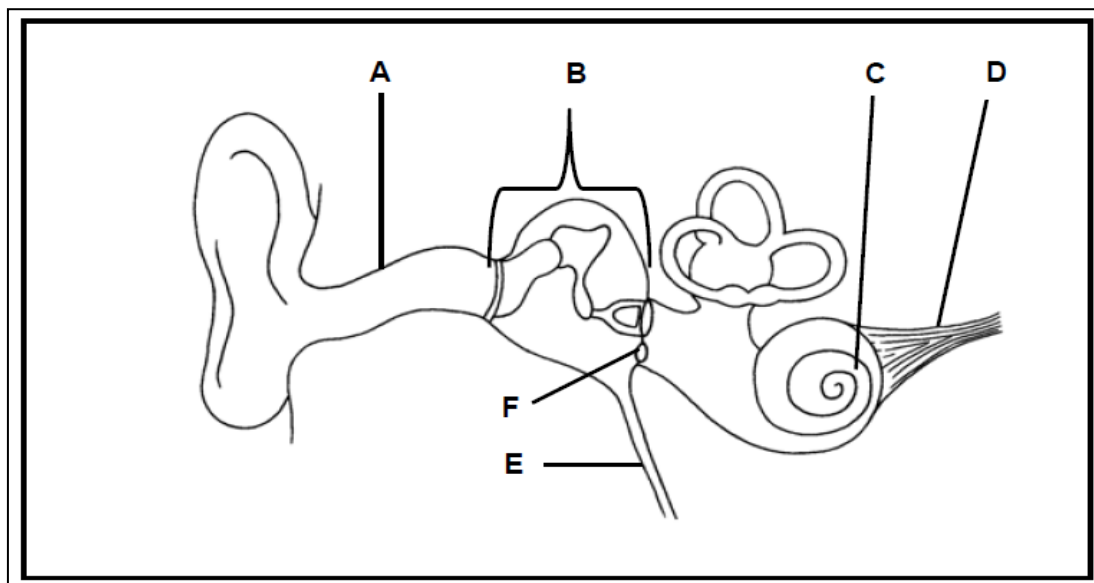

- 7.1 Give ONE function of part:
- (a) A (1)
  - (b) E (1)
  - (c) F (1)
- 7.2 Write down only the LETTER of the part where sound is transmitted in the form of:
- (a) A pressure wave in a liquid (1)
  - (b) An electrical impulse (1)
- 7.3 Explain the effect if the receptors in region C are damaged. (3)
- 7.4 Describe how the parts of the middle ear, including the membranes, assist with amplifying sounds. (3)
- (11)**

**QUESTION 8** (DBE June 2019 P1)

The graph below shows the speed at which impulses are transmitted along sensory neuron axons of increasing diameter when the axons are myelinated (covered with myelin sheath) and unmyelinated (no myelin sheath present).

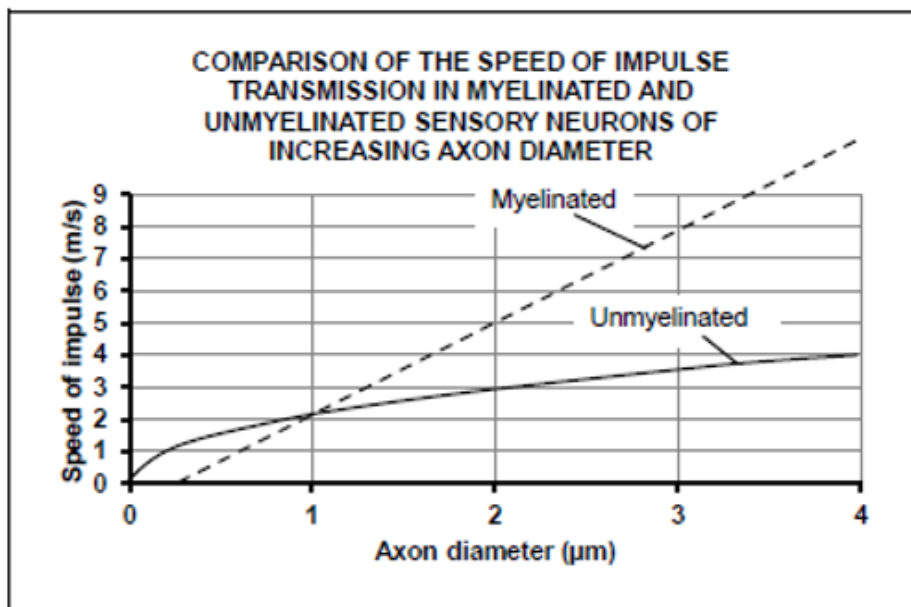

- 8.1 Describe the direction of the impulse within a neuron. (2)
- 8.2 Give the diameter (in  $\mu\text{m}$ ) when the speed of the impulse is faster in unmyelinated axons than in myelinated axons. (2)
- 8.3 Describe the relationship between axon diameter and the speed of the impulse in myelinated axons. (2)
- 8.4 Use evidence from the graph to explain the effect of multiple sclerosis on a sufferer whose motor neuron axons are greater than  $1\mu\text{m}$  in diameter. (3)
- (9)**

# MARKING GUIDELINE: TYPICAL EXAM QUESTIONS

## HUMANS RESPONDING TO THE ENVIRONMENT

### QUESTION 1: Multiple Choice

1.1	A	✓✓		
1.2	D	✓✓		
1.3	A	✓✓		
1.4	B	✓✓		
1.5	A	✓✓		
1.6	B	✓✓		
1.7	D	✓✓		
1.8	C	✓✓		
1.9	C	✓✓		
1.10	C	✓✓	(2 x 10)	(20)

### QUESTION 2: Terminology

2.1	Cerebellum		✓	
2.2	Choroid	✓		
2.3	Corpus callosum		✓	
2.4	Hypothalamus		✓	
2.5	Peripheral nervous system		✓	
2.6	Optic nerve		✓	
2.7	Meninges		✓	
2.8	Multiple sclerosis		✓	(1 x 8) (8)

### QUESTION 3: Columns

3.1	A	✓✓		
3.2	B	✓✓		
3.3	None	✓✓	(2 x 3)	(6)

### QUESTION 4

4.1	(a)	Spinal cord	✓	
	(b)	Corpus callosum	✓	(2)
4.2	(a)	D✓ Cerebrum	✓	
	(b)	B✓ Medulla oblongata	✓	
	(c)	E✓ Cerebellum	✓	(6)
				<b>(8)</b>



## QUESTION 5

5.1 Long-sightedness ✓ (1)

5.2 (a) The lens becomes opaque✓/ milky/ cloudy and therefore,  
does not allow the light to pass through ✓ (2)

(b) Surgery✓ (1)

5.3 -The lens is less convex ✓/the eyeball is too short/cornea is flat  
-This causes the light rays to fall behind the retina✓  
-A biconvex lens increases the refractive powers✓  
-Therefore light rays are focussed on the retina to form a clear image✓

(4)

5.4 Astigmatism ✓

(1)

5.5

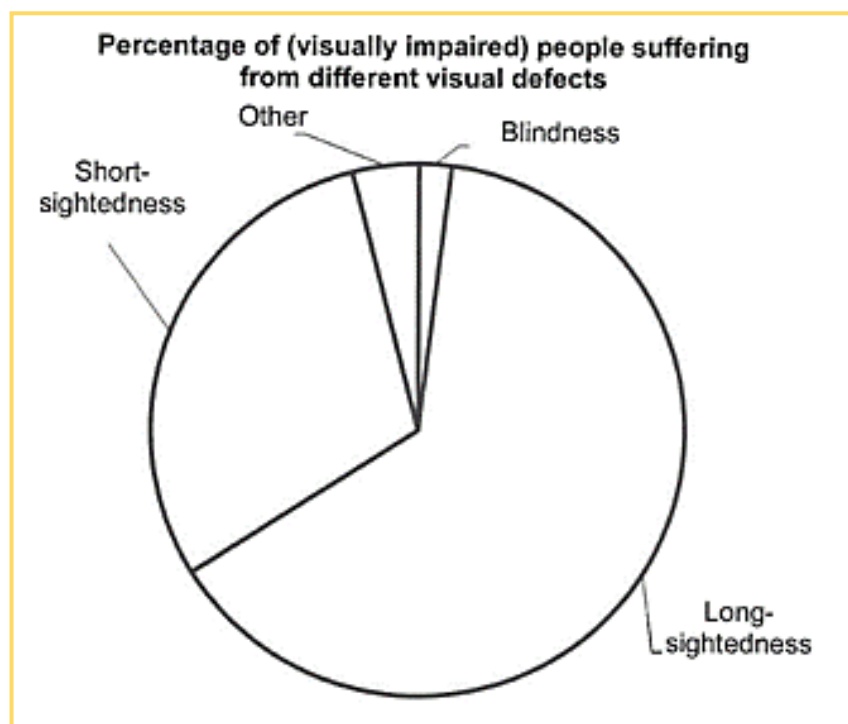

### Calculations:

$$\text{Blindness: } 2/100 \times 360^\circ = 7.2^\circ$$

$$\text{Short sightedness: } 30/100 \times 360^\circ = 108^\circ$$

$$\text{Long sightedness: } 64/100 \times 360^\circ = 230.4^\circ$$

$$\text{Other: } 4/100 \times 360^\circ = 14.4$$

### Rubric for assessment of the Pie Chart

CRITERION	MARK ALLOCATION
Pie chart drawn	1
Title of the graph shows the relationship between the two variables	1
Correct calculations to determine the proportions	2: all 4 correct 1: 1-3 correct
Correct proportions for the labelled sectors	2: all 4 sectors correct 1: 1-2 sectors correct

#### QUESTION 6

- 6.1 (a) E✓  
 (b) A✓  
 (c) C✓ (3)
- 6.2 F✓ motor neuron✓ (2)
- 6.3 D to E✓ (1)
- (6)**

#### QUESTION 7

- 7.1 (a) A: Transmits sound waves to the tympanic membrane ✓/  
 secretes ear wax  
 (b) E: Equalises pressure on both sides of the tympanic membrane✓  
 (c) F: Releases pressure waves from the inner ear✓/ prevents echoes  
 in the ear (3)
- 7.2 (a) C✓  
 (b) D✓ (2)
- 7.3 -The damaged receptors cannot convert the stimuli into impulses✓  
 -No impulses/ fewer impulses are transmitted to the cerebrum ✓  
 -and the person does not hear anything✓/ hearing is impaired (3)
- 7.4 -The ossicles transmit the vibrations✓  
 -from the large tympanic membrane✓  
 -to the smaller oval window✓  
 -which concentrates the vibrations✓, amplifying them. (3)
- (11)**

## QUESTION 8

- 8.1 From the dendrite✓ to the axon ✓ (2)
- 8.2 0 to 1µm✓✓/ 0 to 0.9µm (2)
- 8.3 As the axon diameter increases so the speed of the impulse increases✓✓ (2)
- 8.4 A multiple sclerosis sufferer will have axons that are partially or completely unmyelinated  
The speed of the impulse will decrease compared to an unaffected axon✓  
This results in impulses taking longer to reach the effectors✓  
Thus causing the person to react more slowly ✓ (3)
- (9)**

## RESPONDING TO THE ENVIRONMENT : PLANTS (13 MARKS)

TERM	3	PAPER	1
DURATION	4 hours (1 weeks)	WEIGHTING	13 marks (4.5 %)
<b>PRIOR-KNOWLEDGE/BACKGROUND KNOWLEDGE</b>			
Grade 10 plant tissues: Meristematic tissue			
Apical buds- causes stem to grow tall in length(tall)			
Lateral buds promote growth of lateral branches, resulting in growth in width			
Hormone- grade 12 Endocrine System			

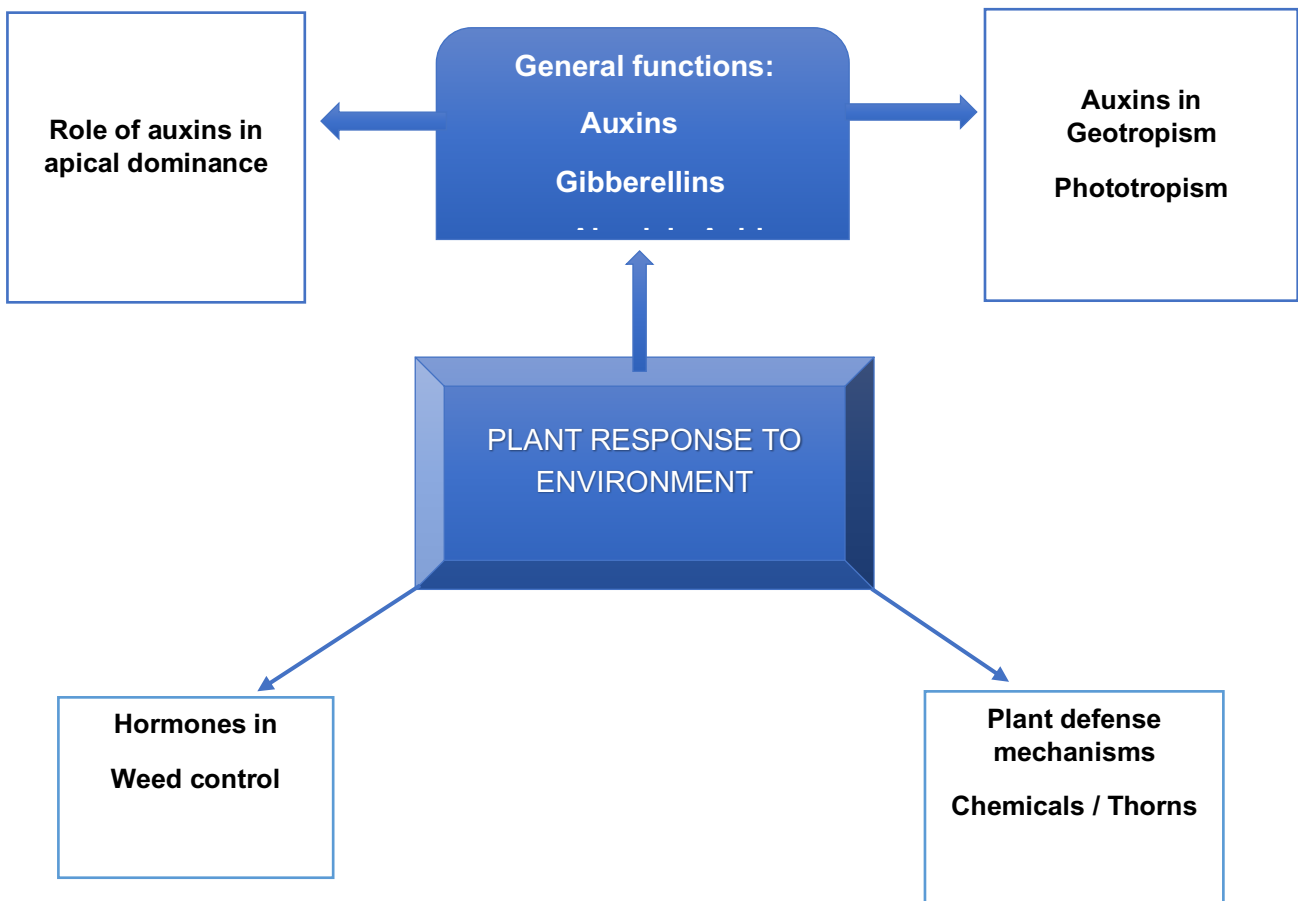

- These substances are **not true hormones** because they **work in the part of the plant** where they are **produced**.
- Therefore, they are also referred to as **plant growth substances**

## TERMINOLOGY

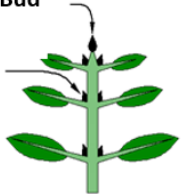
BIOLOGICAL TERM	DESCRIPTION
<b>Abscisic acid</b>	The plant hormone that promotes seed dormancy/ A plant hormone that causes leaves to fall off trees in autumn.
<b>Agar</b>	A jelly-like nutrient medium
<b>Apical dominance</b>  <div style="display: flex; align-items: center;"> <div style="margin-right: 10px;"> <p>Active apical Bud</p> <p>Dormant Lateral Bud</p> </div>  </div>	Inhibition of the growth of lateral buds by the terminal bud of a shoot. This phenomenon is caused by auxins that are produced at the tip of the stem (apical bud) which inhibit the growth of the lateral branches.
<b>Auxin</b>	The plant hormone that promotes root and stem growth
<b>Clinostat</b>	A device which uses rotation to remove the effects of gravitational pull on plant growth.
<b>Coleoptile</b>	A protective sheath covering the emerging shoot in monocot plants
<b>Geotropism</b>	The growth of part of a plant in response to gravity.
<b>Gibberellin</b>	A plant growth hormone that stimulates seed germination.
<b>Herbicide</b>	Chemical used to kill weeds
<b>Hormone</b>	Chemicals messenger that allows a plant to respond to some stimulus in the environment
<b>Plumule</b>	Stem of an embryo plant from the germinating seeds
<b>Phototropism</b>	The growth of a plant in response to light
<b>Radicle</b>	Part of the plant embryo that develops into the root
<b>Shoot</b>	The part of the embryo in the germinating seed that later develops to a stem
<b>Tropism</b>	The growth movement of a plant or part of a plant in response to an environmental stimulus
<b>Unilateral light</b>	Light from one direction only.
<b>Uniform light</b>	Light of the same quality from all directions

# EXAM TIPS AND TECHNIQUES

## PLANT RESPONSE TO THE ENVIRONMENT

Refer to: Mind the Gap pages 60 to 64, DBE textbook pages 236 to 256

Read about the roles of auxin, gibberellin, abscisic acid

### The effect of Auxins on Roots:

**Role of Auxins in Geotropism: How do the roots and shoot of a young plant respond to gravity?**

**A germinating seed placed in a dark cupboard.**

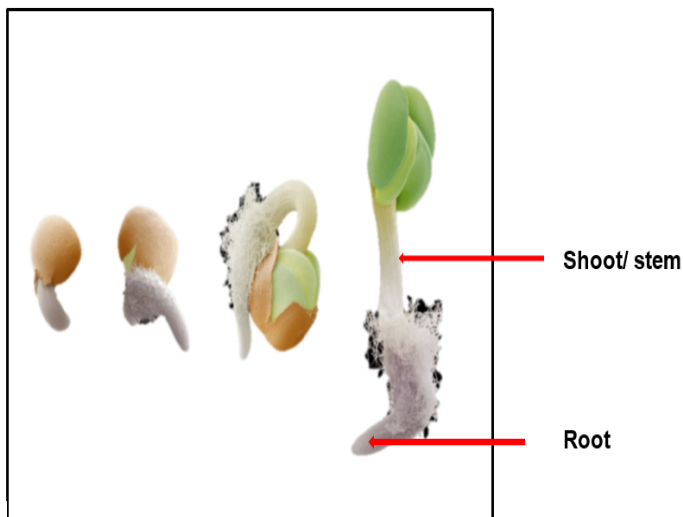

- Plant is in the dark, there is no light
- Uneven distribution of auxin in roots and stem is caused by gravity
- Gravity pulls auxins to the lower side of roots and stem
- There is a high concentration of auxins on lower side of roots and stem
- High auxin in lower side of root-inhibits growth, hence the upper side grows faster causing the root to bend downwards towards gravity
- High auxin concentration in lower side of stem stimulates the lower side to grow faster than upper side, causing the stem to bend upwards away from gravity

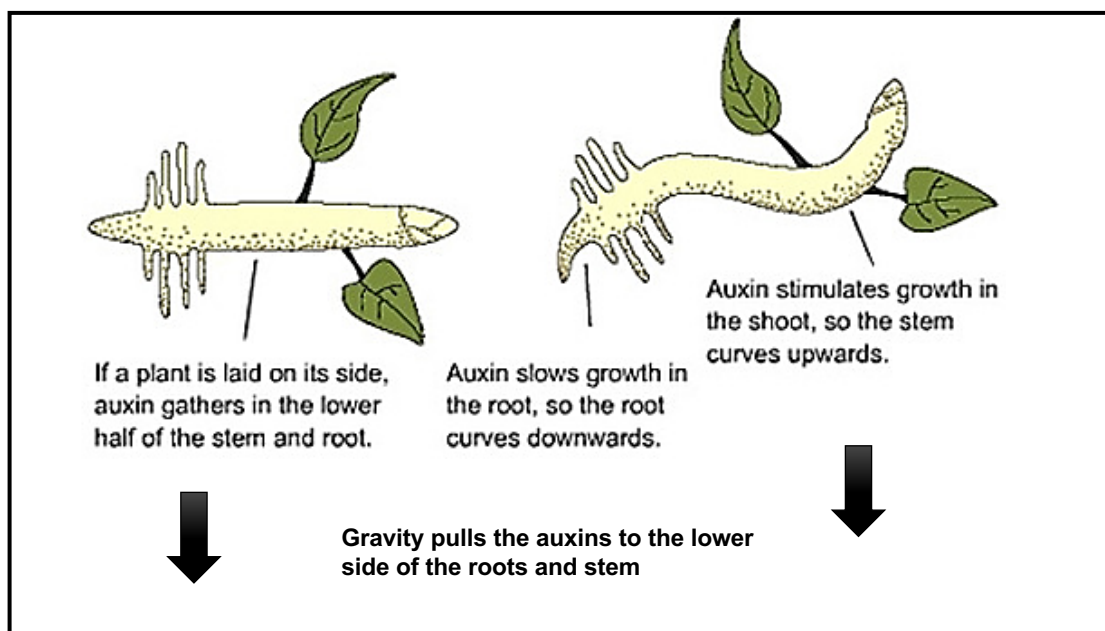

### Experiment showing geotropism

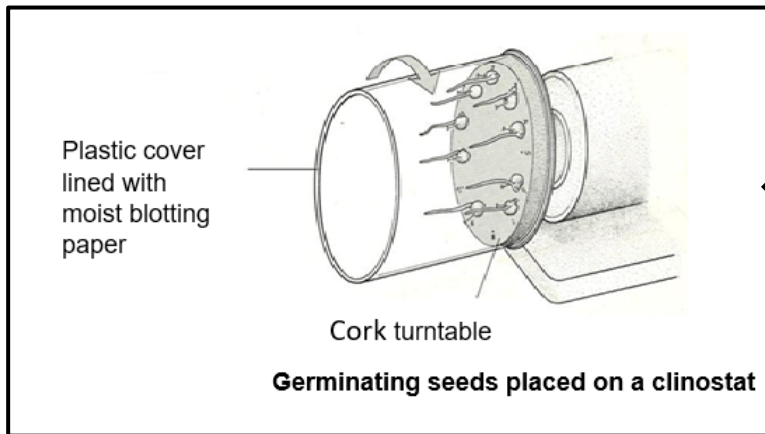

**Control** – the clinostat turns continuously, gravity is experienced from all sides, and hence the roots will grow in a straight line  
Auxins evenly distributed, thus even growth.

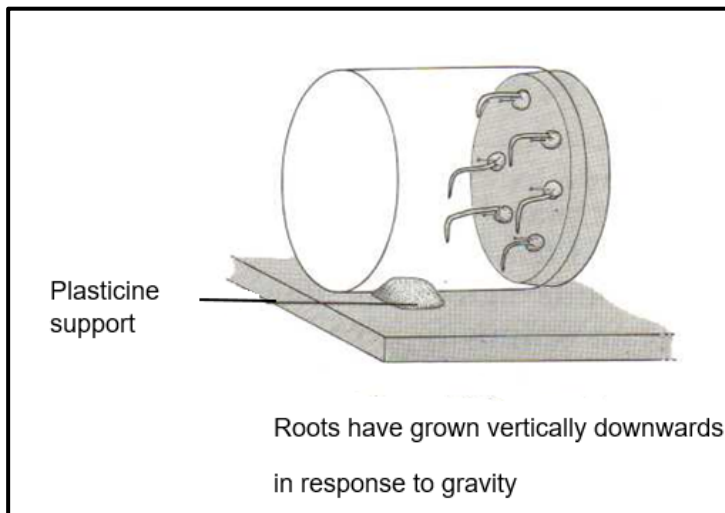

**Experiment** – the clinostat does not turn, is stationary. Gravity stimulates the seeds from the bottom, and auxins accumulate on the lower side, inhibiting growth of the root, thus the root will grow downwards.

NOTE: Table in MIND THE GAP on page 63 explaining how roots responds to gravity when the plant is in an upright position and also when the stem is lying horizontally.

## THE EFFECT OF AUXINS ON SHOOTS: PHOTOTROPISM

Note the effect of light on auxin distribution. Equal auxin distribution promotes even growth

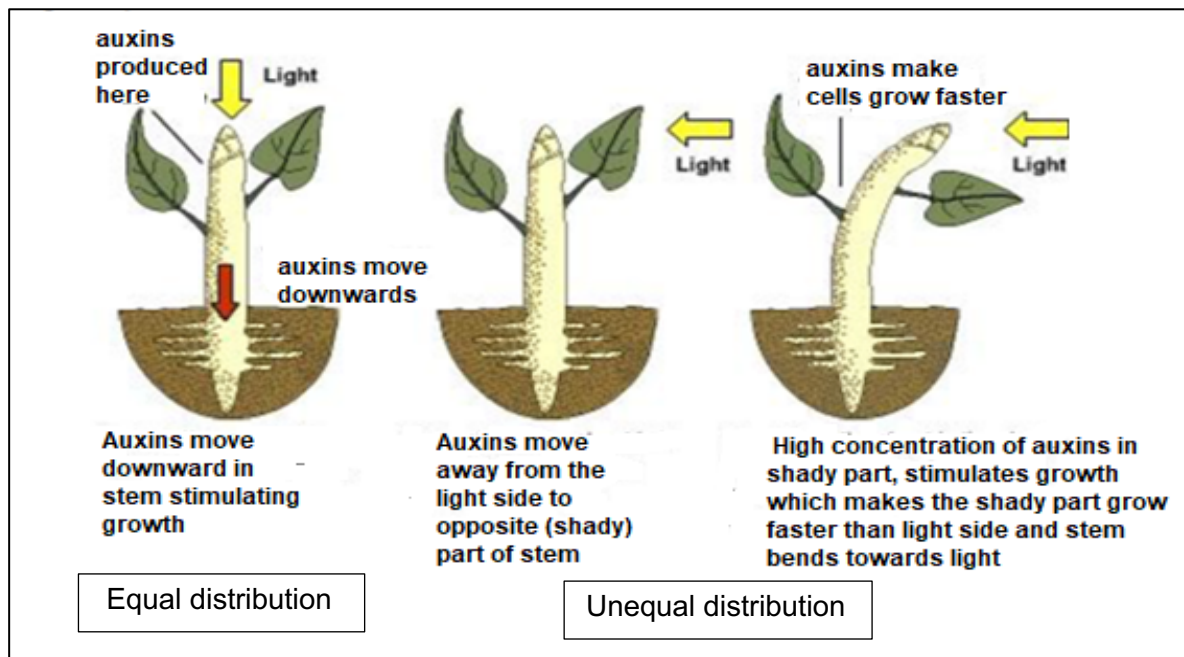

### Experiment showing phototropism

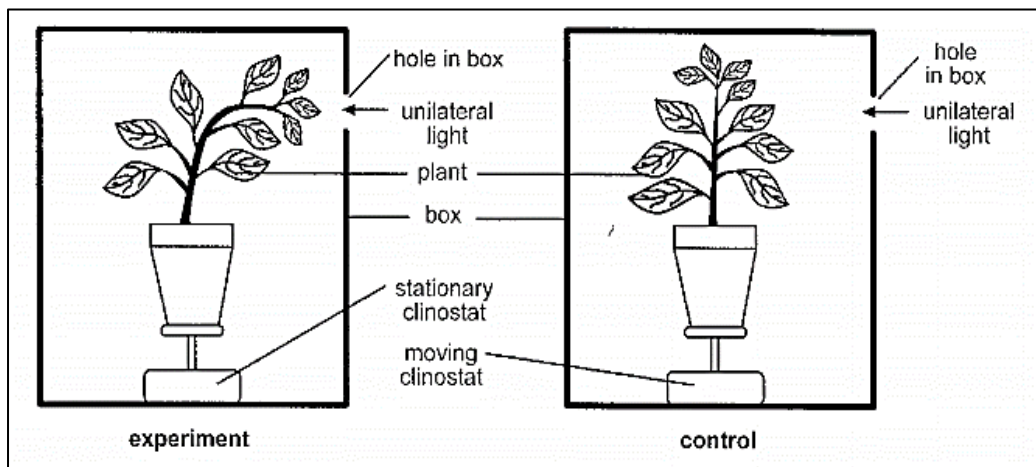

#### Control-

- clinostat moves and turns the plant.
- Light reaches all sides of the plant equally.
- Auxins are evenly distributed, thus there is even growth
- and the plant grows upwards

#### Experiment-

- clinostat does not move.
- Light reaches plant from only one side.
- Auxins are unevenly distributed, thus there is uneven growth
- and the plant bends towards light
- because of the elongation of cells on shaded side of stem.



**Note:** Past examination questions on plant response are based on scientific investigation

- Be able to identify the stimulus acting on the plant.
- Understand the effect of a rotating clinostat

**TABLES COMPARING THE RESPONSE OF PLANTS TO LIGHT AND GRAVITY UNDER NORMAL GROWTH CONDITIONS AND WHEN CONDITIONS ARE MANIPULATED**

<b>PHOTOTROPISM (light from all sides)</b>	<b>GEOTROPISM (plant upright position)</b>
Auxin <b>produced</b> at the <b>tip of the stem/shoot</b>	Auxin <b>produced</b> at the <b>tip of the root</b>
This even distribution brings about equal growth on all sides of the stem	This even distribution brings about equal growth on all sides of the root
As a result, the <b>stem grows upward</b>	As a result, the <b>root grows downward</b>
This is called <b>positive phototropism</b>	This is called <b>positive geotropism</b>
<b>PHOTOTROPISM (unilateral light)</b>	<b>GEOTROPISM (plant lying on side)</b>
The auxin <b>concentration</b> will be <b>high</b> on the <b>dark side</b> – light destroys auxins	The auxin <b>concentration</b> will be <b>high</b> on the <b>lower side</b> of the root – gravity attracts auxins
<b>More growth</b> occurs on the <b>dark side</b> because auxins <b>stimulate growth</b> on the dark side	<b>More growth</b> occurs on the <b>upper side</b> of the root because auxins on the lower side <b>inhibit growth</b>
<b>Stem</b> bends <b>towards the light</b>	<b>Root</b> bends <b>downwards</b>
This is called <b>positive phototropism</b>	This is called <b>positive geotropism</b>

<b>PHOTOTROPISM</b>	
<b>Multi-directional light (from all sides)</b>	<b>Unilateral light (light from one side only)</b>
Auxins move <b>downward</b> evenly	The auxin <b>concentration</b> will be <b>high</b> on the <b>dark side</b> – light destroys auxins
This even distribution brings about equal growth on all sides of the stem	<b>More growth</b> occurs on the <b>dark side</b> because auxins <b>stimulate growth</b> on the dark side
As a result, the <b>stem grows upward</b>	<b>Stem</b> bends upwards <b>towards the light</b>

GEOTROPISM	
Plant upright position	Plant horizontal position (on side)
Auxin <b>produced</b> at the <b>tip of the root</b>	The auxin <b>concentration</b> will be <b>high</b> on the <b>underside</b> of the root
This even distribution brings about equal growth on all sides of the root	<b>More growth</b> occurs on the <b>upper side</b> of the root because auxins on the lower side <b>inhibit growth</b>
<b>Root grows downward</b> and the <b>shoot grows upwards</b>	<b>Root bends downwards</b> and the <b>shoot bends upwards</b>

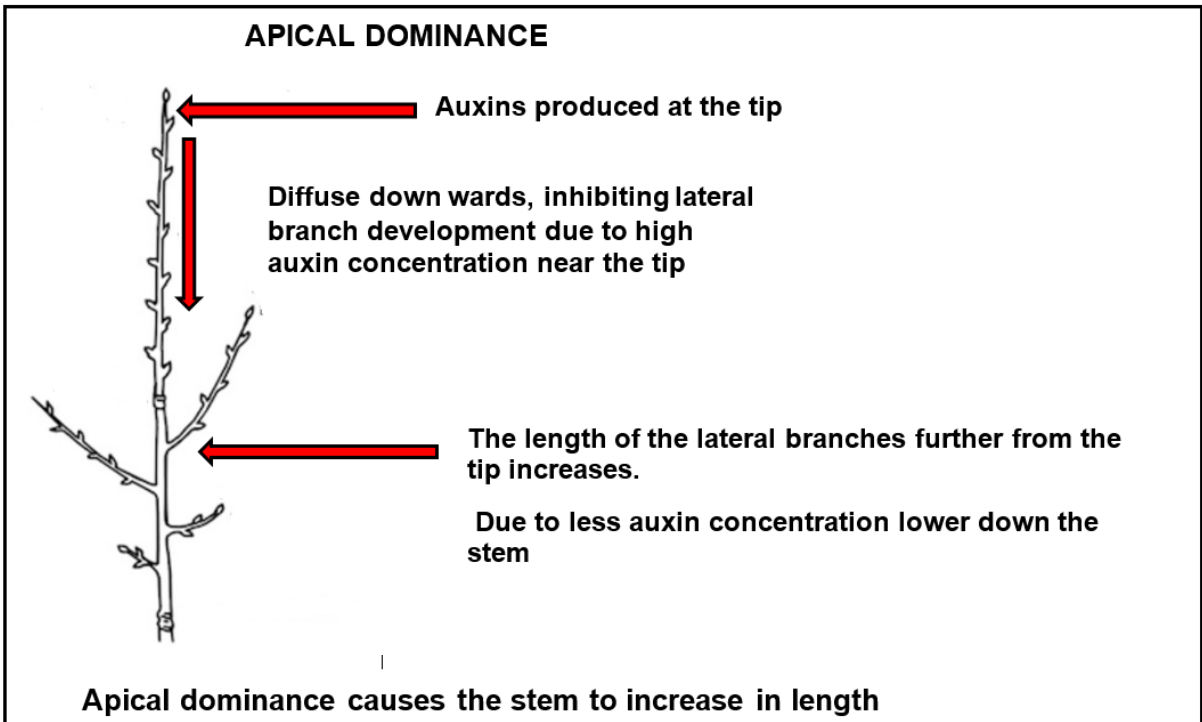

**REMEMBER**

Auxins are produced at the tip of the stem (stimulate cell, elongation and growth)  
Auxins are also produced at the tip of the roots

In roots a high concentration of auxins inhibits growth, the side with more auxins will grow slower

In shoots (stem) a high concentration of auxins stimulates growth, the side with more auxins will grow faster

## GENERAL FUNCTIONS OF PLANT HORMONES

AUXINS	GIBBERELLINS	ABSCISIC ACID
<p><b>Stimulate:</b></p> <ul style="list-style-type: none"> <li>• Cell division</li> <li>• Cell elongation (growth in stem length)</li> <li>• The development of fruit</li> <li>• The abscission of leaves and fruit</li> <li>• The development of adventitious roots in stem cuttings</li> <li>• Tropic movement in stem and roots</li> <li>• Apical dominance: it suppresses the growth of the lateral buds</li> </ul>	<ul style="list-style-type: none"> <li>• Stem elongation</li> <li>• Root growth</li> <li>• The germination of seeds</li> <li>• Promotes flowering</li> </ul>	<ul style="list-style-type: none"> <li>• Is an <b>inhibitor of growth</b></li> <li>• Causes plants to become dormant in winter</li> <li>• Abscission in leaves and fruit</li> <li>• Lack of water (water stress) stimulates the production of Abscisic acid</li> <li>• Causes the closing of stomata when the plant wilts</li> </ul>

## PRACTICE QUESTIONS- EXAM TIPS/TECHNIQUES

### QUESTION 1

- 1 The diagram below represents a germinating seed. Assume that the radicle and plumule were exposed to uniform light from all directions.

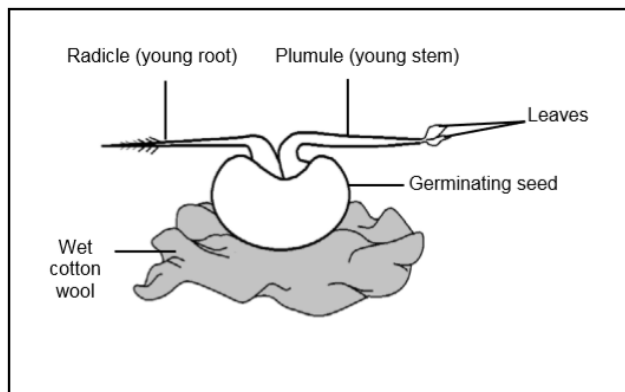

- 1.1 **Define tropism.** (1)  
*Do not define geotropism and phototropism, no stimulus is involved.*
- 1.2 **Draw a labelled diagram to show the position of the radicle and plumule in the seedling one week later.** (4)

Diagram must have a heading and correct label, clearly showing how the roots and stem responded to the gravity

Step 1- Determine the stimulus involved, since light is from all directions, it will cause equal distribution of auxins- therefore no tropism

Step 2- Identify the stimulus which will cause unequal distribution of auxins: in this case it is gravity

Step 3- Draw the radicle growing downwards because gravity caused the accumulation of auxins on the lower side of the roots, inhibiting cell elongation. Thus the upper side with less auxins will grow faster and bend downwards.

Step 4- Draw the stem bending upwards because of the accumulation of auxins on the lower side stimulated growth causing the lower side of the stem to grow faster and the stem to bend upwards.

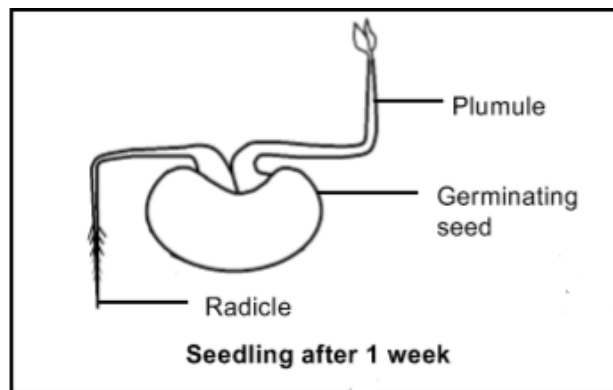

RUBRIC FOR MARKING DIAGRAM		
Criterion		mark
Plumule facing upwards	✓	1
Radicle facing downwards	✓	1
Any two correct labels	✓✓	2

1.3 Describe which side will have a higher concentration of auxins on the young root and young stem (1)

The lower side of roots and stem✓ have a higher concentration of auxins

## QUESTION 2

A clinostat is a device used to investigate plant growth responses. It has a disc that rotates very slowly when the clinostat is switched on.

During an investigation on plant responses to light, the procedure below was followed:

- Three pot plants of the same species were used.
- Each pot plant was placed on one of three identical clinostats.
- Each set of apparatus, A, B and C, was placed in a box with a single opening.
- Each clinostat was treated in a different way over a period of five weeks.

The results of the investigation are represented in the diagrams below.

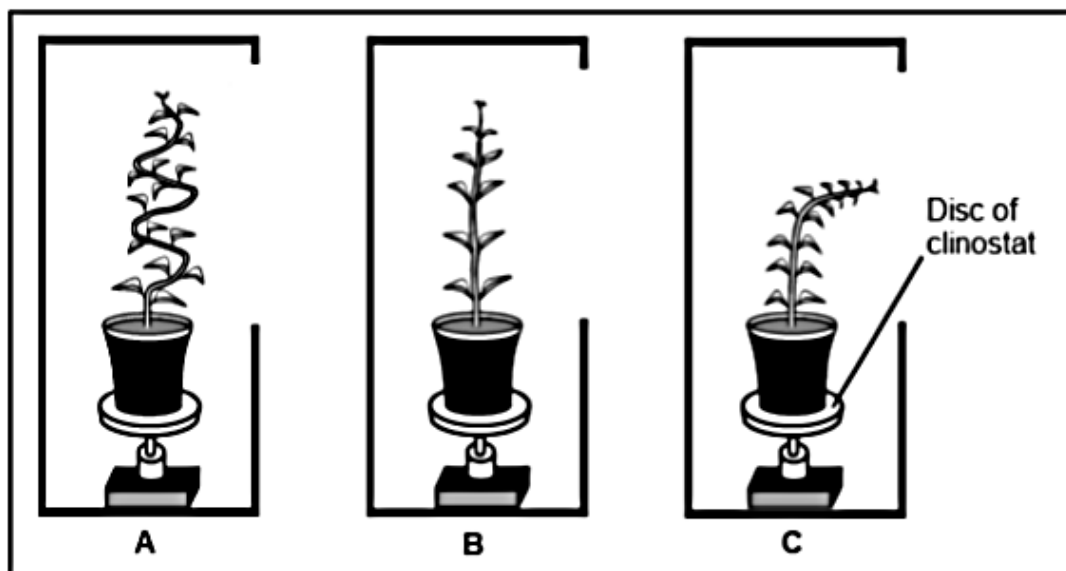

2.1 Give ONE reason why the results of this investigation may be considered unreliable. (3)

- *To answer a question on reliability check the sample size used. It must be large.*
- *Also check the duration of the investigation from the given information, for reliability it must be conducted over a long period.*
- *Determine whether the investigation was done once or repeated*
- *Do not confuse reliability with validity which is based on other variables affecting the investigation that must be kept constant*

Investigation was not repeated✓, set up was done once✓, and sample size was small (only one plant was used in each set up✓)

2.2 Give FIVE factors that were kept constant during the investigation. (5)

*Read the procedure to identify the variables that were kept constant in all experimental set ups. Identify which treatment was applied in each set up*

- The same species of plant was used in the set up✓
- Identical clinostats were used in each set up✓
- The same period of time/5 weeks was used for each set up✓
- Each apparatus was placed in a box with a single opening✓
- Opening on each box was in the same position/ was the same size✓

2.3 Explain the effect of the unilateral light on the distribution of auxins in the plant in Apparatus C. (3)

- *Underline keyword in the question (unilateral light)*
- *Look at diagram C and note how the stem has responded*
- *Identify the side which has a higher or lower auxin quantity*
- *Clearly indicate what caused the change and what the effect on the stem was*
- *Compare auxin concentration on each side of the stem*
- *Link auxin concentration to cell elongation and relative growth (which side will grow fast and which side will grow slow)*

The auxins moved away from the light ✓/ were destroyed by the light

The shaded side had a higher concentration of auxins✓

The light side had a lower concentration of auxins✓

2.4 In which apparatus (A, B or C) was the clinostat: (1)

**(a) Switched on and rotating slowly**

- *Rotation exposes all sides of the stem to equal amounts of light.*
- *The sides of the stem will contain equal amounts of auxin*
- *Stem will grow straight upwards*

B✓

**(b) Switched off, but manually rotated through 180° once a week** (1)

- *Manual rotation for once a week will cause one side to be exposed to unilateral light for a short while.*
- *Auxin distribution will be unequal.*
- *Shaded side will have more auxin than the side receiving the light. There will be unequal cell elongation and growth on each side.*
- *Shaded side will grow faster than side facing the light.*
- *Stem will bend towards the light.*

*NOTE: the sides exposed to light will be different each week, hence the plant is bending towards light at different places in different directions*

A✓

### QUESTION 3 (DBE, Feb 2018, Paper 1)

A group of Grade 12 learners investigated the **influence of different concentrations of auxins on plumule growth**. A plumule is a young stem that grows from a seed.

The procedure was as follows:

- 35 bean seeds were germinated.
- The seedlings were then divided into five groups of seven seedlings each.
- In each group the seven seedlings were attached with Prestik to filter paper on which a 10 mm x 10 mm grid was drawn.
- The filter paper with seedlings was then glued to the inside of a petri dish.
- Each of these five petri dishes was placed in a beaker containing a different concentration of auxins.

The diagram below shows the set-up of a single beaker.

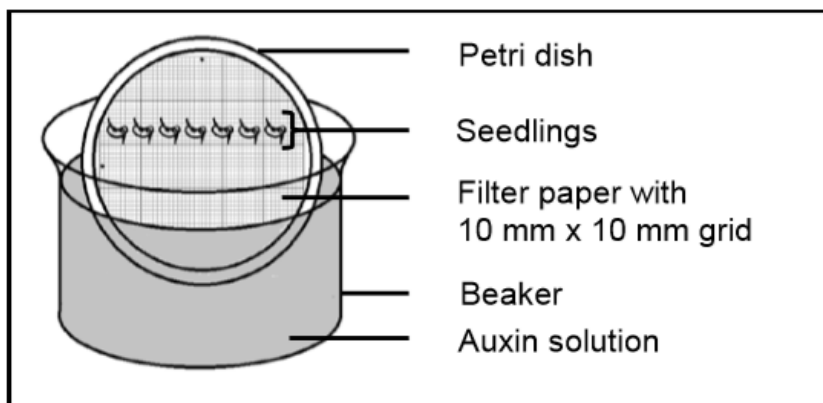

- All 5 beakers were placed inside a dark cupboard for 3 days.
- After 3 days the increase in the length of each plumule was measured.
- The average increase in length of the plumule in each beaker was calculated and recorded in the table below.

The table below shows the results of the investigation after three days

BEAKER NUMBER	AUXIN CONCENTRATION IN PARTS PER MILLION (ppm)	AVERAGE INCREASE IN PLUMULE LENGTH (mm)
1	0,1	1,5
2	1	3,2
3	10	4,8
4	50	2,3
5	100	0

3.1 For this investigation identify the:

(a) Independent variable (1)

(b) Dependent variable (1)

(c) Measured variable (1)

- *The dependent and independent variables are stated as part of the aim.  
Identify the two variables in the aim (see underlined part).*
- *Identify which of the two variables can be changed by the person doing the investigation.*
- *In this question only the concentrations of auxins can be changed.*
- *Identify the variable that will respond to the changed variable.*

(a) **Independent variable** – auxin concentration ✓

- *The independent variable which is the manipulated variable automatically causes the change in the dependent variable (cause and effect relationship exists between the two variables).*
- *In this case the growth of the plumule changes when the auxin concentration changes*
- *Note that sometimes the aim of the investigation is not given, a learner must then read the procedure that was followed in the investigation to identify the variable manipulated*



(b) **Dependent variable-** plumule growth✓

*Note that marks will be lost if you write auxin in 3.1 (a) without referring to concentration.*

*Marks will be lost in 3.1 (b) if you write plumule without referring to growth.*

(c) **Measured variable**

- *Although the table shows average plumule length, it is not the independent variable, but is the measured variable that was used to estimate the extent of plumule growth.*

Average length of the plumule✓

**NOTE :** *If the question is:*

***Draw a bar graph based on the results in the table. .***

*The caption of the graph will be based on the variables on the table and not on the variables stated in the aim of the investigation.*

**CAPTION:** **Average increase in plumule length at different auxin concentrations.**

Remember to include **units in the Axis labels on the graph**

3.2 **State the purpose of the grid that was placed inside each petri dish.** (1)

To measure the length of the plumule✓ (*it has a grid with measurements*)

3.3 **Explain why the beakers were placed in a dark cupboard.** (2)

- *An investigation can only have one independent variable.*
- *Other factors which might affect plumule growth must be eliminated/ or be kept constant to ensure validity*
- *Note: light can affect distribution of auxins in the plumule resulting in growth*

to expose the seedlings to uniform light✓ so that no other variable is introduced/to ensure validity✓

or

to simulate the same conditions✓ under which germination takes place for the normal growth✓ of the seedlings

3.,4 **State ONE way in which the learners ensured the reliability of this investigation** (1)

- *Many plumules were measured per treatment, so average values measured give reliable results as opposed to taking one measurement.*

Large sample size used ✓ ( 35 bean seeds in total/ 7 seedlings in each group

Average increase in plumule length was measured ✓

3.5 **State THREE factors, not indicated in the procedure that should be kept constant during this investigation.** (3)

*Only state other factors to be kept constant that do not appear in the questions.*

- Same species of beans✓
- Seedlings of the same age✓
- Seedlings of the same size✓
- Same temperature✓
- The same investigator✓
- Identical apparatus(beakers)petri-dishes/graph paper/grid/volume of solution✓

3.6 **State the conclusion that can be made from the results in the table** (2)

- *The conclusion must be based on the results which must first be analysed.*
- *Identify the trend in the results, it must show the relationship between the independent and dependent variable (cause and effect relationship).*
- *The conclusion must link to the aim of the investigation.*

An increase in auxin concentration up to an optimum stimulates the growth rate of the plumules/stem. With further increase in auxin concentration there is an inhibition of plumule /stem growth✓✓

#### QUESTION 4

**An investigation was done to determine the effect of a plant hormone on plant growth:**

**The procedure was as follows:**

- Two pot plants (1 and 2) of the same species and age were used.
- The apical buds of both plants were cut at the same length along the stem.
- The cut surface of plant 1 was sealed with petroleum jelly.
- The cut apical bud of pot plant 2 was placed on a block of agar jelly for 2 hours.
- The block of agar jelly was then placed on the cut surface of plant 2.
- The plants were exposed to the same environmental conditions for 2 weeks.
- The growth of both plants was observed at the end of this period.

The diagrams below show the results obtained.

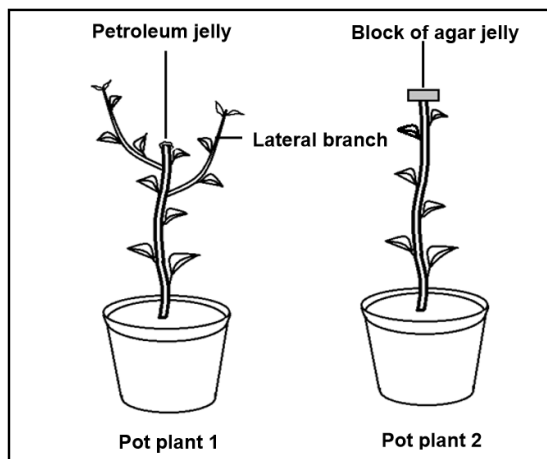

- 4.1 State why the apical bud was placed on a block of agar jelly for 2 hours. (2)

*You must recall that auxins are produced at the apical bud. Apical bud has a high auxin concentration. Once apical bud is put on agar block, the auxins will diffuse from the cut apical bud into agar block*

To allow enough time for the auxins in the apical bud✓ to diffuse into the block of agar jelly✓

4.2 **Describe the results obtained for plant 1** (2)

*Look at plant A and observe how it differs from plant B in terms of:*

- *stem length*
- *development of lateral branches*

Stem stopped growing upwards✓ and lateral branches developed✓

4.3 **Explain how fruit farmers can use the knowledge from the results in QUESTION 4.2 to their benefit** (2)

- *Link lateral branch development to fruit yield.*
- *Think of the effect of the plant height on the harvesting process, shorter trees means that the fruit can be harvested without having to climb onto ladders in the orchards*

Removal of apical bud, promotes development of lateral branches✓

Longer lateral branches will bear more fruit✓

A shorter stem/tree develops lateral branches near the ground ✓

Makes fruit harvest easier✓

4.4 **Explain why the stem in pot plant 2 grew upwards.** (3)

- *Identify the substance in the agar that promotes growth*
- *Link to growth to cell division and cell elongation.*

Auxins✓ in the block of agar jelly

Moves downwards✓ into the stem

Causing cell elongation ✓/growth

Resulting in the stem growing straight upwards

## EXAM TYPE QUESTIONS- SOURCED FROM PAST DBE EXAM QUESTION PAPERS

### QUESTION 1(DBE, Nov 2018, Paper 1)

1. The diagrams below represent the growth responses of two different plant organs to external stimuli.

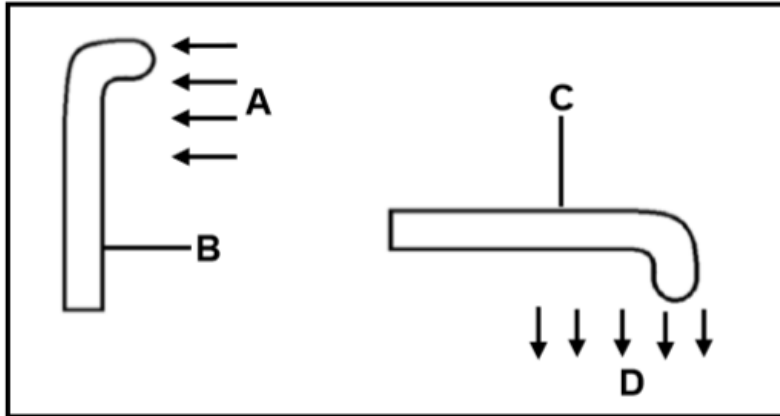

- 1.1 Name the group of plant hormones that is responsible for the growth responses observed in the diagrams. (1)
- 1.2 Name the external stimulus at:  
a) A (2)  
b) D
- 1.3 Give ONE observable reason why plant organ B is a stem. (1)
- 1.4 Explain the growth response observed in plant organ C. (3)  
(7)

**QUESTION 2 DBE NOV 2014 P1**

2. A learner conducted an investigation to determine the effect of auxins and the effect of gravity on root growth in pea seedlings. He used the following procedure:

- He germinated pea seeds for seven days.
- He then took a sample of 15 seedlings and divided them into 3 groups (A to C) of 5 seedlings each.
- In each group the 5 seedlings were placed horizontally on 3 different clinostats.

A clinostat is a device which has a disc that rotates at a constant speed. A diagram of a clinostat is shown below.

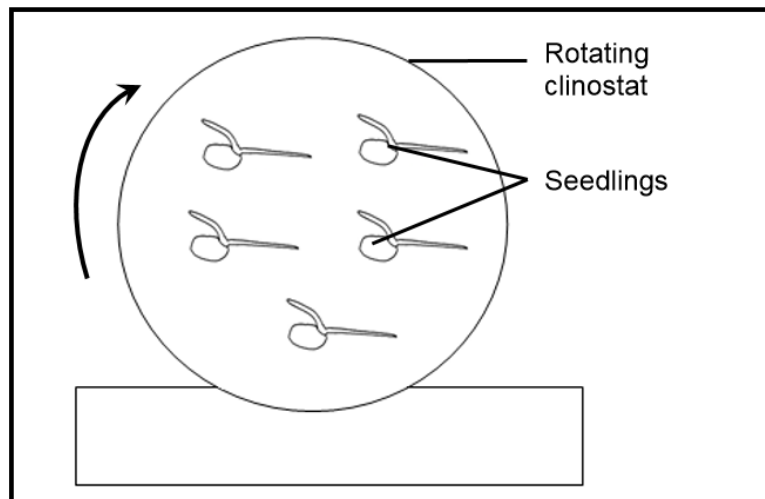

He removed the root tips of all 5 seedlings at the same length in group B.

- In groups A and B the clinostats were left stationary (no rotation).
- In group C the clinostat was allowed to rotate.
- All 3 clinostats were placed in a dark cupboard

A summary of the learner's procedure is shown in the table below:

GROUP A	GROUP B	GROUP C
Root tips present	No root tips	Root tips present
Stationary clinostat	Stationary clinostat	Rotating clinostat

After two days the direction of growth was observed

- 2.1 Which TWO groups were used to obtain information about:
- (a) The effect of auxins on root growth (1)
- (b) The effect of gravity on root growth (1)
- 2.2 Explain why the apparatus was placed in a dark cupboard. (2)
- 2.3 Describe the expected results for each of groups B and C in this investigation. (2)
- 2.4 Explain the expected results for group A. (3)
- 2.5 State THREE ways in which the learner ensured a high level of validity for this investigation. (3)
- (12)

### QUESTION 3 DBE June Paper 2013

3. A learner investigated **the effects of two plant growth substances, gibberellins and auxins, on apical dominance**. The apical buds of nine pea plants of the same species, age and height were removed. These plants were then divided equally into three groups. In each group the cut surface of the remaining shoot (growing stem) of the pea plants was treated in one of the following ways:

Group 1: Coated with a paste containing gibberellins of the same concentration

Group 2: Coated with a paste containing auxins of the same concentration

Group 3: Coated with a paste only (containing no plant growth hormones)

The hormones diffuse into the plant until no more hormones remain in the paste.

- The treated plants were all grown under the same conditions in the laboratory.
- The length of the lateral branches of each plant was measured after every two days for a period of 12 days.
- Measurements were taken at the same time for all treated plants and the average for each group was calculated.

The results of the investigation are shown in the graph below.

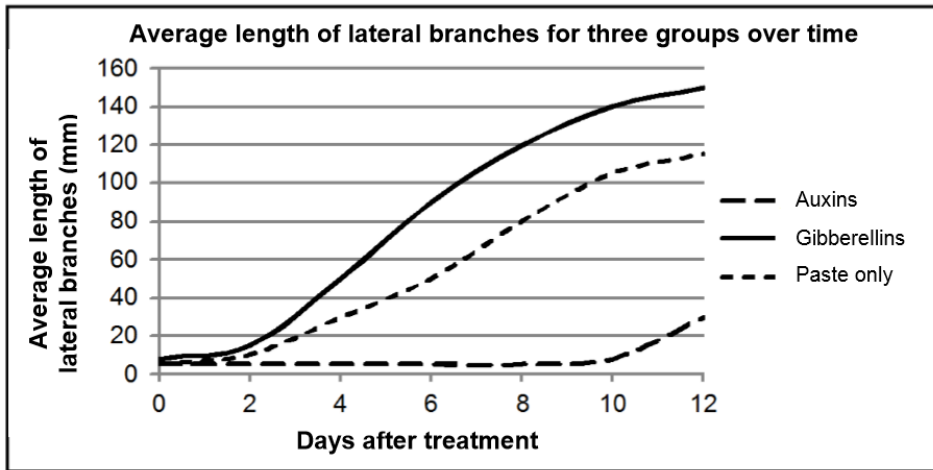

- 3.1 State ONE function of the gibberellins that led to the results obtained in the investigation. (1)
- 3.2 Calculate the difference in the average length of the lateral branches between the plants treated with gibberellins and the plants treated with the paste only on the 8th day after the treatment. Show ALL working(s). (3)
- 3.3 State TWO ways in which the reliability of the investigation could be increased. (2)
- 3.4 Use the results to explain the effect of auxins on the growth of the lateral branches. (4)

**(10)**



#### QUESTION 4

- 4 A group of Grade 12 learners set up the following apparatus in their classroom. Two plants were used. One was placed on a clinostat that rotated (Diagram A) and the other was placed in a stationary position (Diagram B). They left the apparatus in these positions inside a dark cupboard for two weeks before making the observations as indicated in the diagram below.

NOTE: A clinostat is an apparatus that is able to rotate.

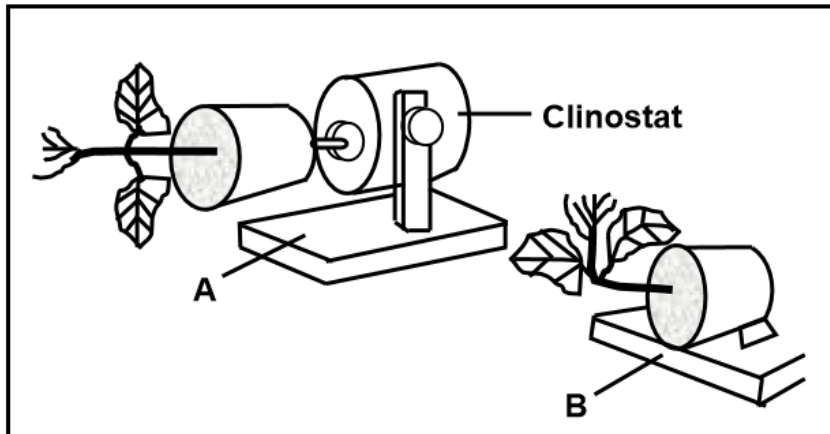

- 4.1 What type of plant growth movement was observed? (1)
- 4.2 Briefly explain the results observed in:
- (a) A (3)
- (b) B (4)
- 4.3 State ONE reason why the apparatus was placed in a dark cupboard for the duration of the investigation. (1)
- (9)

### QUESTION 5

The diagrams below show an investigation that was done to determine the effect of auxins and gravity on the growth of a stem.

A clinostat was used in the investigation. It is a device with a disc that rotates when switched on, allowing the attached plant to rotate as well.

The investigation was set up as follows:

**Diagram A:** Plant placed horizontally on a rotating clinostat

**Diagram B:** Plant placed horizontally on a stationary clinostat

**Diagram C:** Plant with tip cut, placed horizontally on a stationary clinostat

The plants were all exposed to uniform light.

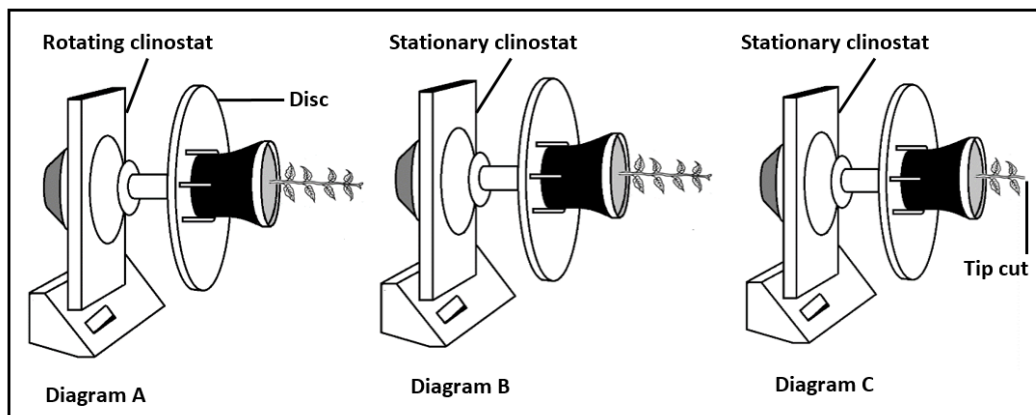

5.1 Which TWO diagrams (**A**, **B** or **C**) show the apparatus used to investigate the effect of:

(a) Gravity on the growth of the stem (2)

(b) Auxins on the growth of the stem (2)

- 5.2 Give the LETTER of the diagram where the expected result is that the stem will:
- (a) Grow horizontally (1)
  - (b) Not grow (1)
  - (c) Grow away from gravity (1)
- (7)**

## SOLUTIONS TO EXAM TYPE QUESTIONS

### QUESTION 1

- 1.1 Auxins✓ (1)
- 1.2 a) Light✓  
b) Gravity✓ (2)
- 1.3 Plant structure B has bent towards the light✓/towards A/positively phototropic  
-Auxins accumulated on the lower side✓ of the root (1)
- 1.4 -the high concentration of auxins on the lower side of the root inhibits growth✓  
the lower concentration of auxins on the upper side stimulates growth✓  
Causing uneven growth✓ / the root to bend downward/positive geotropism (3)
- (7)**

### QUESTION 2

- 2.1 (a) A and B✓ (1)
- (b) A and C✓ (1)
- 2.2 To ensure that the results are attributed to gravity✓  
And not light✓ / to eliminate the effect of light (2)
- 2.3 B- No growth will be observed✓ (1)
- C- Roots will grow horizontally / no change in direction✓ (1)

2.4 Auxins will move to the lower side of the root ✓ / attracted by gravity  
 And a high concentration will inhibit growth on the lower side of the root ✓  
 While growth will occur faster on the upper side of the root ✓  
 Causing the root to bend downwards towards gravity ✓  
 Any THREE (3)

2.5 Used same type of plant/ pea plant ✓  
 Seedlings were of the same age ✓ / germination period was 7 days  
 All groups were exposed to the same environment ✓ / light intensity/ placed  
 in a dark cupboard  
 Same number of seedlings for each group ✓  
 Root tips were cut at the same length ✓  
 All seedlings were placed in the same position / horizontally ✓  
 Allowed same amount of time for the three groups ✓  
 Appropriate controls were set up ✓ (3)

**QUESTION 3**

3.1. Gibberellins stimulate cell elongation ✓ / cell enlargement / growth in stems / elongation  
 of internodes  
**(Mark first ONE only)** Any (1)

3.2  $(120 - 80) \text{ mm} = 40 \text{ mm}$  ✓ (3)

3.3 Increase the number of plants used in each treatment ✓  
 Repeat the investigation ✓  
 Increase the period of the investigation ✓  
**(Mark first TWO only)** Any (2)

3.4 Auxins diffused from the paste into the plants ✓  
 inhibiting growth of the lateral branches ✓  
 Once all the auxins were used up ✓ from the paste  
 the growth of the lateral branches increased ✓ (4)  
**(10)**

#### QUESTION 4

- 4.1 Geotropism ✓ (1)
- 4.2 (a) - As the plant was constantly rotating, there was an equal distribution of auxins throughout the stem ✓ - therefore, there was no unequal growth of the stem ✓ - And the stem continued to grow straight ✓ (3)
- (b) - As the plant was placed on its side, auxins accumulated at the lower side of the stem ✓ - because of the gravitational force ✓ - A high concentration of auxins on the lower side of the stem stimulated the growth of the stem ✓ - Thus, unequal distribution of auxins caused unequal growth of the stem on the lower side ✓/the stem grew more on the lower side - causing the stem to bend/grow upwards ✓ (Any 4) (4)
- 4.3 To eliminate the effect of light ✓ on the growth movement of the stems / To prevent phototropism from influencing the results (1)

#### QUESTION 5

- 5.1 (a) A✓ and B✓ (2)  
**(Mark first TWO only)**
- (b) B✓ and C✓ (2)  
**(Mark first TWO only)**
- 5.2 (a) A✓ (1)  
(b) C✓ (1)  
(c) B✓ (1)  
**(Mark first ONE only) (7)**

## REFERENCES

- DBE Exam guidelines for learners
- GDE ATP
- 2015-2020 NSC past papers
- 2014-2020 national diagnostic report on learner performance
- Approved grade 12 national textbooks
- Internet
- Gauteng grade 12 Life Sciences Revision booklet
- Gauteng grade 12 Life Sciences Exam Kit

## ACKNOWLEDGEMENTS

The Department of Basic Education (DBE) gratefully acknowledges the following officials for giving up their valuable time and families and for contributing their knowledge and expertise to develop this resource booklet for the children of our country, under very stringent conditions of COVID-19:

Writers: Wendy Coertze, Phumzile Dlamini

Reviewers: Ruby-Joan Bopape, Willard Maphangwa, Sapina Ndhlovu, Azhar Rajah, Kenneth Makhubele, Mark Doolan, Matsoku Tselahale, Jacob Makua, Jabulani Chauke

DBE Subject Specialist: Kanthan Naidoo

The development of the Study Guide was managed and coordinated by Ms Cheryl Weston and Dr Sandy Malapile

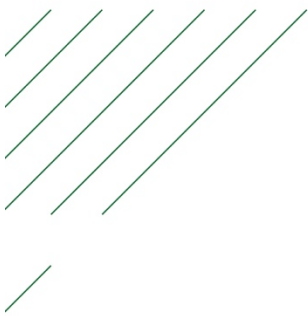
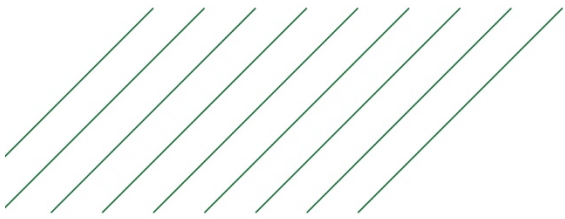
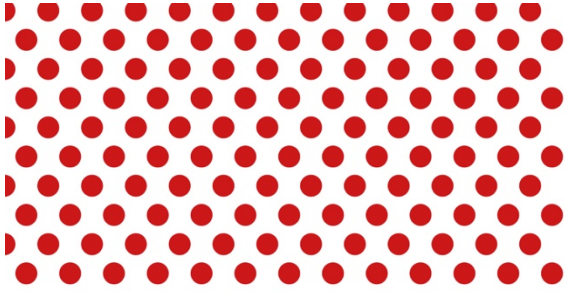

**basic education**  
Department:  
Basic Education  
REPUBLIC OF SOUTH AFRICA

ISBN: 978-1-4315-3519-4  
High Enrolment Self Study Guide Series  
This publication is not for sale.  
© Copyright Department of Basic Education  
[www.education.gov.za](http://www.education.gov.za) | Call Centre 0800 202 993